

a
to
Z
in audio

G. A. Briggs

technical editor: R. E. Cooke B.Sc.(Eng.)

Gernsback Library Book No. 97



\$3.20
(in the U.S.)

A TO Z IN AUDIO

by

G. A. BRIGGS

Author of

"LOUDSPEAKERS" "SOUND REPRODUCTION" "PIANOS, PIANISTS AND SONICS"

and

(with H. H. Garner)

"AMPLIFIERS: THE WHY AND HOW OF GOOD AMPLIFICATION"

and

(with R. E. Cooke)

"HIGH FIDELITY: THE WHY AND HOW FOR AMATEURS"

"STEREO HANDBOOK"

Assisted by

R. E. COOKE, B.Sc. (Eng.)

as Technical Editor

First U.S. Edition 1961

Published by Gernsback Library, Inc.

New York, N. Y.

British Edition: WHARFEDALE WIRELESS WORKS LIMITED
IDLE :: BRADFORD :: YORKSHIRE

*British Copyright
Registered at Stationer's Hall*



Copyright © 1961 Gernsback Library, Inc.

*All rights reserved under Universal
International, and Pan-American
Copyright Conventions.*

Library of Congress Catalog Card No. 61-12273



ABOUT THE AUTHOR

G. A. BRIGGS was born in Yorkshire, England, in 1890, left school at the age of 15, and went to work in the Bradford textile industry.

More interested in musical sounds than in the rag trade, he started dabbling in pianos as a hobby at the age of 20. No less than 40 uprights and grands passed through his hands during his search for perfection in piano tone.

Finding pianos rather heavy and cumbersome, he turned his attention to loudspeakers in 1932, and started to make experiments at home in the attic and a few speakers in the cellar, opening a small factory in 1933 and leaving the textile industry once and for all.

In 1948—quite by accident—he wrote an 88-page book on *Loudspeakers*. Having borrowed £500 from the bank, he made a trip to New York, where he sold 1,000 copies of the book. This eventually opened up the American market for his Wharfedale speakers (and enabled him to repay the bank).

Encouraged, he turned to writing as a hobby. His *Sound Reproduction, Pianos, Pianists and Sonics, Amplifiers, High Fidelity, Stereo Handbook* and now *A to Z in Audio* have sold more than 150,000 copies. Readers obviously enjoy both his Yorkshire humor and his clarity of expression in technical matters. Three of his books have been translated into French, two into Dutch, and one into Rumanian.

In 1954, in his native city of Bradford, G. A. Briggs gave his first concert-hall demonstration of live and recorded music. Astonished at the interest shown by the general public, he booked the Royal Festival Hall in London for a similar demonstration. All seats were sold within 3 weeks. During the following 6 years, ably and generously assisted by BBC and recording engineers, amplifier makers, technical staff and, of course, musicians, more than 20 similar demonstrations have been given, including four in the Festival Hall and two in New York's famous Carnegie Hall.

Now 70, Mr. Briggs is managing director of the Bradford Wharfedale speaker factory. He still does a bit of writing in his spare time—witness *A to Z in Audio*—and still practices half an hour a day on his Steinway, but his tempos are more andante than allegro and never presto or agitato.

*A little learning is a dangerous thing;
Or so the famous Pope was wont to sing.
But if you make a hobby of the art
Of reproducing sound and wish to start
To understand its technicality;
Then A to Z in Audio's the Key.*

INTRODUCTION

On a sunny Sunday afternoon in February 1960 (yes, we can have a fine day in February—even in Yorkshire) I was taking a stroll with an old friend of mine, Mr. E. E. Ladhams, when he suddenly stopped walking and said: “You must bring out another book on audio: a sort of glossary which will answer most of the questions which puzzle the amateur, and outline some of the facts which even the experts may forget. But”, he continued, “the book must be interesting, readable and spiced with humour.”

I told my friend not to ask for the moon when the sun was shining.

Next day I mentioned the idea to Mr. Cooke, our Technical Editor, and within twenty-four hours he came through with a list of about 500 possible words and headings which might be dealt with. This set the ball rolling, and here is the result of our efforts. In order to keep within reasonable limits, the number of headings has been whittled down to about 400.

According to Mr. F. G. G. Carr, Director of National Maritime Insurance, Greenwich:

Copying from one book is clearly “cribbing”; copying from two is “research”; and if one can get somebody else to do the copying this becomes a “project”.

I suppose I must admit that for me this book is a project, but when I totted up and examined the situation re illustrations, I was agreeably surprised to find that out of 160 no less than 110 are original in the sense that they have been specially prepared for this issue. Sixteen are taken from outside sources, leaving only about thirty from other Wharfedale publications. So the book is not just a *Potage du Jour*.

We should like to thank Mr. M. G. Foster of the Engineering Information Department of the B.B.C. for most useful assistance on questions relating to radio and television; *The Financial Times* for furnishing valuable facts and figures, and finally our old friend F. Keir Dawson for doing most of the drawings.

G. A. BRIGGS

N.B. In order to simplify reference to INITIALS, these are dealt with first under each letter of the alphabet.

The books on *Amplifiers* and *High Fidelity* listed on page 3 are out of print.

A

AC Abbreviation for alternating current. A periodic current having a substantially sinusoidal waveform. Domestic electrical power is usually distributed in this form at a frequency of 50 c/s in Great Britain and 60 c/s in the U.S.A.

A.E.S. Audio Engineering Society of America. Secretary C. J. Le Bel, Box 12, Old Chelsea Station, New York 11, N.Y.

AF Audio frequency. The range is normally taken as 20 c/s to 20,000 c/s.

AFC Automatic frequency control. A useful refinement in a radio tuner which operates to keep the local oscillator adjusted to the correct frequency for stable reception of the selected stations. Its use is highly desirable in FM receivers which tend to drift off tune due to thermal effects.

AM Amplitude modulation; the most important system of modulation used in broadcasting throughout the world. The amplitude of the carrier wave is varied in sympathy with the information to be transmitted, thus:



FIG. A/1. *Amplitude modulation.*

A.R.D. Arbeitsgemeinschaft der öffentlich-rechtlichen Rundfunkanstalten der Bundesrepublik Deutschland. (Now we know!)

AVC Automatic volume control. A circuit refinement used in radio tuners for AM reception. It adjusts the gain of the radio frequency amplifying stages in accordance with aerial signal strength so as to maintain the audio output at an almost constant level. In this way large changes in volume are avoided when tuning from weak to strong stations or vice versa. In the U.S.A. the term automatic gain control (AGC) is used and is more precise.

ABSORPTION When sound waves impinge on a body—human or material—a proportion of the incident energy is reflected, some is absorbed by the body and the remainder is transmitted through it, as shown in Fig. A/2.

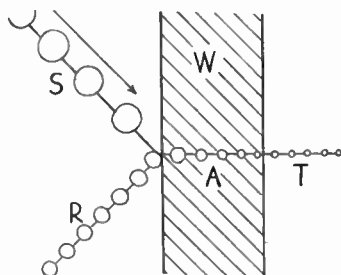

FIG. A/2.

Sound wave *S* strikes wall *W*.
R = energy reflected;
A = energy absorbed;
T = energy transmitted.

The ratio of sound energy absorbed (or transmitted) to the total energy is called the absorption coefficient and often varies enormously with the frequency. The most effective is an open window, but this can hardly be classed as a material. The following table gives average values for a variety of materials at six different test frequencies, taken from an American book by Burris-Meyer and Goodfriend, *Acoustics for the Architect*.

ABSORPTION COEFFICIENTS

MATERIAL	Cycles per second					
	125	250	500	1000	2000	4000
WALLS AND CEILINGS						
Brick024	.025	.031	.04	.05	.07
„ painted012	.013	.017	.02	.023	.025
Concrete or stone01	.01	.02	.02	.02	.03
„ painted01	.01	.01	.02	.02	.02
Cinder block30	.50	.40	.30	.50	.30
„ painted15	.15	.10	.12	.15	.15
Solid wood $\frac{3}{4}$ \"10	.11	.10	.08	.08	.11
Plywood $\frac{5}{16}$ \"11		.12		.10	
Plaster, smooth024	.027	.030	.037	.019	.034
„ scratched025	.028	.060	.085	.043	.056
Glass03	.03	.03	.03	.02	.02
Perforated fibrous tiles $\frac{3}{4}$ \"	.05	.30	.80	.80	.70	.60
FLOORS						
Cork tile on concrete08	.02	.08	.19	.21	.22
Linoleum on concrete02	.03	.03	.04	.04	.04
Wood $\frac{3}{4}$ \" thick09		.08		.10	
Carpet, average05	.10	.20	.25	.30	.35
Carpet on rubber15	.20	.55	.80	.75	.70
CHAIR						
Upholstered and occupied	2.5	3.0	3.5	3.0	3.0	4.0
	to	to	to	to	to	to
	3.5	4.0	4.5	5.0	5.0	5.0

The ideal is to have a reasonable amount of absorption to suit the room and give a satisfactory reverberation time, say 0.5 second in the average living room. For stereo, the ideal conditions are less lively than for single channel reproduction. Incidentally, we recently heard an excellent stereo demonstration by the B.B.C. Research Dept. in a room of domestic size, for which a panel of BAF wadding about 8 ft. wide and 6 ft. high had been placed between the two loudspeakers, as shown in Fig. A/3.

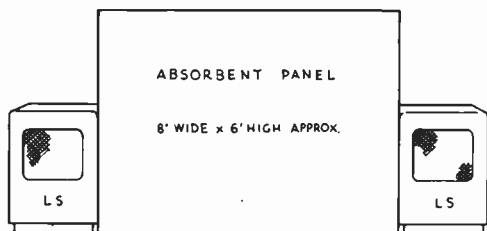

Fig. A/3. Absorbent surface placed between loudspeakers to improve stereo.

Similarly, a large window or hard wall between speakers in a domestic set-up could with advantage be covered by thick curtains or other absorbent material effective in middle and upper registers.

The absorbent properties of materials vary greatly with thickness and method of mounting. Absorption at low frequencies is improved by using greater thicknesses of absorbent and spacing the material several inches away from the wall.

At very low frequencies, say below about 100 c/s, soft porous materials have little effect and absorption depends upon large flexible surfaces such as wooden floors and ceiling structures not specially reinforced. When necessary—to reduce room resonance—these can be supplemented by installing damped resonant panels of plywood or roofing felt.

Small Enclosures. The use of absorbent materials in cabinets—cotton-wool, fibreglass, soft felt, bonded acetate fibre, etc.—is becoming more and more common as enclosures are reduced in size, one reason being that standing waves and resonances occur at higher frequencies where they are more objectionable, being heard mainly through the LS cone.

Another reason is that the bass output is reduced along with enclosure volume and it becomes necessary to apply some HF absorption treatment in order to preserve a good balance, which is the main object in speaker design. Remarkably good overall results are now possible in acoustically-designed enclosures of about 2 cu.ft., with clean and full bass down to around 30 c/s.

ACOUSTIC FEEDBACK In a public address system some of the sound energy radiated by the loudspeakers may be returned to the microphone, thus reinforcing the input. In certain conditions this can cause continuous oscillation or howling. Microphonic valves can also produce similar effects in gramophone and radio equipment, especially at high volume. The only cure in the public address case is to reduce the amount of energy transferred from loudspeaker to microphone by reducing amplifier gain or employing highly directional microphones and/or loudspeakers. Cardioid or ribbon microphones and line source loudspeakers are particularly valuable in difficult cases.

Another form of acoustic feedback, often referred to as mechanical feedback, occurs between loudspeaker and pickup/turntable assembly when loud bass passages are played and cabinet resonance is transmitted through floor vibration or directly if speaker and turntable are mounted together, as in Fig. A/4.

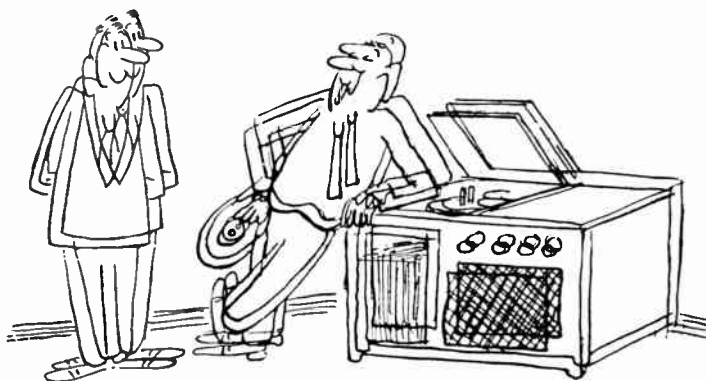

*"Now here comes the part I was telling you about . . .
Just listen to that bass."*

Courtesy Australian Magazine, MAN.

FIG. A/4. *Slight acoustic feedback.*

Loud grunting and groaning noises may be heard as the resonances build up. Remedies are: (1) greater rigidity; (2) spring mounting for turntable; (3) stand loudspeaker on a thick, soft pad; (4) choose rigid section of floor; (5) cut out excessive bass.

ACOUSTIC FILTER A configuration of acoustic elements designed to transmit certain audio frequencies and restrict others. A specific type of acoustic filter may be used in bass reflex cabinets to attenuate middle and high

frequencies emanating from the vent, and thereby reduce interference effects with direct cone radiation. The filter also helps to reduce standing waves within the enclosure and prevents overloading by signals below the lower cut-off frequency of the system. The filter may take the form of a layer of felt, or a sheet of plywood with slits or small holes.

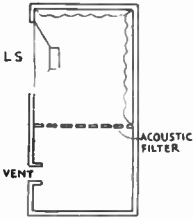

FIG. A/5. Reflex enclosure with Acoustic Filter. Ordinary saw-cuts $1\frac{1}{2}$ " apart make suitable slits. Absorbent lining in upper section only.

ACOUSTIC IMPEDANCE Any surface or body which restricts the flow of sound energy is said to offer acoustic impedance. By definition, the acoustic impedance at a surface is the complex ratio of the average sound pressure over the surface to the volume velocity through it. The unit is the dyne sec/cm⁵ or acoustic ohm.

ACOUSTIC LABYRINTH A type of loudspeaker enclosure in which the rear of the cone is loaded by a pipe designed to be a quarter wavelength long at or near the fundamental resonance frequency of the unit. The pipe is folded so that its mouth is brought near to the radiating unit.

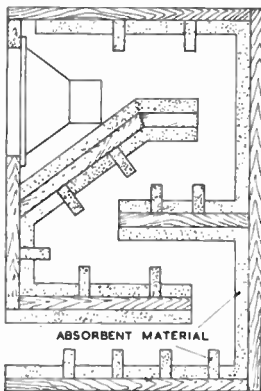

FIG. A/6. Typical acoustic labyrinth.

In the octave above the fundamental resonance of the driving unit the action of the pipe retards the phase of the rear radiation

so that it leaves the mouth in phase with the frontal energy and provides reinforcement. At still lower frequencies the high impedance of the pipe damps the cone resonance.

Although the labyrinth gives good bass performance for its size it is liable to suffer from response irregularities at middle frequencies due to interfering radiation through the pipe.

In theory, it is very nice to talk about making a pipe a quarter wavelength long at the cone resonance of a given loudspeaker, but as the resonance frequency alters when the unit is mounted, the job should be tackled by Chan Canasta.

ACOUSTIC LENS A device which increases the angle over which the higher frequencies are spread. It is often fitted to horn-loaded tweeters which would otherwise become sharply directional above a few thousand cycles per second.

ACOUSTIC POWER The rate of dissipation of sound energy. It is equal to the product of acoustic resistance and the square of the volume velocity through it.

Some idea of the enormous variation in sound energy produced by different instruments is given in the following table, although I personally always take such sound measurements with a large pinch of salt. So much depends on how and where the tests are made and who is playing the instrument. For example, a pianist with no ear for "tone" will make three times as much noise as one who never strains the tonal resources of the instrument. However, here for what it is worth is the table:

<i>Instrument</i>					<i>Peak Power in Acoustic Watts</i>
Bass Drum 36" × 15"	24.6
Cymbals 15" dia.	9.5
Double Bass	0.156
Trombone	6.4
Piano	0.437
15 piece orchestra	9.0
75 piece orchestra	66.5
Pipe Organ	12.6

Table showing peak power of musical instruments.

Courtesy Bell Telephone Labs.

ACOUSTIC RESISTANCE UNIT A device patented and developed by Goodmans Industries Ltd. for use with vented enclosures. It consists of an acoustic resistance of predetermined value in juxtaposition with the usual port opening. This arrangement suppresses the upper resonance peak and it is claimed to extend the low frequency response of the system.

ACOUSTIC TILES These are made from several different materials, including fibreglass, mineral

wool, sugar-cane fibre and asbestos. The absorbent fibres are pressed into flat boards of handy size (usually 1' × 1' or 2' × 2') which are easily fixed to walls and ceilings. The tiles vary in thickness from $\frac{1}{2}$ " to over 1". The thicker grades give more effective absorption at low frequencies. Even better results are possible by spacing the tiles away from the wall by mounting them on battens about 2" thick. The tiles are usually perforated with holes $\frac{3}{16}$ " dia. on $\frac{1}{2}$ " centres, and may be covered with a decorative plastic film, and they provide a most effective method of reducing noise in office or workroom.

AERIAL A system of conductors arranged in space to pick up transmitted radio signals by electro-magnetic induction. An aerial may vary in complexity from a length of wire used to pick up medium wave signals to a complex Yagi* array necessary to achieve a good signal on VHF in a difficult area remote from the transmitter. In cases of doubt the advice of a good dealer should be sought because he is most likely to have had experience of local conditions. The aerial is a very important part of any audio system involving a radio tuner. An inadequate or poorly sited aerial can result in serious distortion on VHF which sounds remarkably like a loudspeaker with a rubbing voice coil.

The feeder between aerial and tuner is also important, especially on VHF or TV. Incorrect type or badly made joints may cause serious mismatching with weak signals on certain stations and/or distortion.

AIR CORED INDUCTOR An inductor having no iron or other magnetic material in its magnetic circuit. Such inductors are limited by practical considerations to values below about 16 mH, but they avoid harmonic distortion caused by hysteresis effects in iron cores, and they are therefore widely used in loudspeaker crossover networks, which must handle large amounts of electrical power without introducing distortion.

AIR LOADING This refers to the methods used to improve the acoustic impedance between the vibrating diaphragm of a loudspeaker and the surrounding air, thus achieving a better transfer of energy. Horn loading is the most efficient over a range of about three octaves. Reflex enclosures tuned to low frequencies improve bass output, and large baffles maintain the loading on the cone by avoiding cancellation from out-of-phase sound waves from the other side.

*Yagi, a Japanese radio engineer who pioneered the use of reflectors and directors with dipole aerials during the 1930's.

ALCOMAX A family of anisotropic permanent magnet alloys widely used in modern loudspeakers. Various grades are available for different applications but Alcomax II and III are most commonly employed in loudspeakers.

Typical composition:

Aluminium	8.0%
Cobalt	24.0%
Nickel	13.0%
Copper	3.0%
Niobium	0.7%
Iron	balance.

Magnets made in America of similar quality are marketed under the trade name Alnico V, etc.

ALIGNMENT In tape reproduction the gaps of the recording and reproducing heads must lie at the same angle relative to the direction of tape motion, otherwise serious loss of high frequencies will result. The need for alignment does not of course arise with machines employing a common record/replay head, but is important if tapes recorded on one machine are replayed on another.

Alignment is carried out by replaying a standard C.C.I.R. test tape and adjusting head azimuth for maximum output in the 8–12 kc/s region. The record head (if separate) is then adjusted for max. whilst monitoring an HF recording signal. It is quite common to find that the optimum positions for two frequencies, say 8 and 10 kc/s, are slightly different. This is due to the fact that the edges of the head gap are not absolutely straight. In such circumstances the azimuth should be adjusted for the best overall result.

ALNICO (BRITISH) A group of isotropic permanent magnet alloys which are lower in alloy content and in magnetic performance than that obtained from the Alcomax series. The British Alnico magnetic material is mainly used for the production of magnets which are embodied in measuring instruments such as ammeters, etc.

Typical composition:

Aluminium	10.0%
Cobalt	12.5%
Nickel	18.0%
Copper	6.0%
Iron	balance.

AMBIENCE This refers to “coloration” of concert hall, studio or room which is present in all recordings except those made out of doors. It varies in character according to the acoustics of the studio, and in extent according to microphone technique.

A "dry" recording is produced by placing the microphone close to the source of sound or by using a directional instrument such as a cardioid or figure-of-eight type to reduce the amount of reflected sound picked up from walls and ceiling. This technique is necessary if the recording is to be reproduced in a larger concert hall, otherwise it sounds as though it had been made in a box; but for domestic use a reasonable amount of ambience in most records is desirable to give the listener a sensation of being in the concert hall, but too much blurs the fine detail.

Ambience and Stereo. One of the most attractive features of stereo is that a good deal of ambience can be incorporated without loss of clarity or naturalness because the hall or studio reverberation appears to be dissociated from the direct sound. (This is just another way of saying that two channels are better than one.)

Programme Source. The superb acoustics of a place like the B.B.C. Studio No. 1 at Maida Vale can be recognised in many broadcast concerts; but an opera from Glyndebourne, although musically of a high standard, suffers from a "padded cell" tone due to the acoustics of the theatre.

In "pop" records, artificial echo and reverberation are often added by turning a knob which controls the echo machine, with a cavernous, bathroomy effect which could reasonably be described as ambience with knobs on.

AMBIENT NOISE Random background noise due to local activity. This varies considerably in domestic rooms according to locality and time of day. Actual measurements in typical homes are as follows:

House in quiet street—mid morning	30 dB
—late at night	25 dB
(The latter figure is virtually silence)			
House near main road—mid morning	40 dB
—late at night	30 dB
Room 30 ft. from main road:			
Car passing uphill	54 dB
General mixed traffic	56 dB
Pneumatic earth ram	58 dB
The same room with window open:			
Car passing uphill	62 dB
Pneumatic earth ram	70 dB

The annoyance factor depends upon frequency distribution of energy. Motor-bikes and pneumatic road-mending tools are judged more annoying than cars and lorries.

Background noise—both indoors and out of doors—is on the increase, thanks to the internal combustion engine, juke boxes and continuous loudspeaker use in cafés, bars, shops, etc. (In due course the quiet places will reap their reward.)

Deaf people are often worried by ambient noise which covers a wide frequency range, as it probably includes the register in which they hear best, and the masking effect makes it difficult for them to hear and comprehend speech which may be pitched in a less favourable frequency range.

AMPERE The unit of electric current named after *André Marie Ampère*, a famous French physicist, who died in 1836. One volt across one ohm produces a current flow of one amp.

AMPLIFIER A device for increasing the voltage, current or power in a circuit. In audio work most of the valve amplifying stages are designed to increase the voltage of the signals fed into them. The final stage is the power amplifier designed to feed the loudspeaker with a few watts of audio power.

AMPLITUDE The maximum value of a movement or signal. In a loudspeaker or pickup the amplitude is the maximum excursion away from the quiescent or neutral position of the mechanism.

AMPLITUDE DISTORTION Simply expressed, this is non-linearity in amplifier, loudspeaker, pickup or microphone due to the amplitude of the incoming signal. Overloading produces it, and the manifestations are harmonic and intermodulation distortion with a hard and gritty sound quality.

Amplitude distortion is difficult to calibrate or specify because tests at spot frequencies are often quite misleading. For instance, give a loudspeaker five watts at 40 c/s and it may produce a wave form similar to the Himalayas, but spread the five watts over a few octaves and you may have something like the smooth undulations of the Sussex Downs.

ANECHOIC Meaning without echo, this term is used to describe heavily damped rooms used for acoustical measurements, known also as dead rooms. The walls, floor and ceiling are usually fitted with wedges of absorbent material which give almost total absorption of sound at frequencies above which the wedges are half a wavelength long. At low frequencies, some allowance for reflection effects has to be made unless a very large room is used—say 30 ft. long *after* treatment with very deep wedges. (See also Free-field.)

ARMATURE Originally this referred to the bar of magnetic material which vibrated between the pole pieces of the magnet system in the old balanced armature loudspeaker.

Today it usually refers to the moving parts in magnetic pickups to which the stylus is attached.

ARTICULATION The intelligibility factor in speech. In an articulation test, a large number of words or syllables are read or reproduced in controlled conditions and the percentage of correct answers recorded by the listeners constitutes the percentage articulation or intelligibility factor.

Articulation is affected by the nature and amount of reverberation and also by ambient or masking noise which may be present.

ASYMMETRY Lacking in proportion or symmetry. Stereophonic reproduction is often affected by rooms which are asymmetrical in the acoustic sense, due to their geometry or furnishing. The sound field radiated by a loudspeaker depends upon the absorption and scattering effects of nearby obstacles. Therefore if the room is lop-sided the performance of two similar speakers disposed on opposite sides of the room may be quite different, thus leading to unbalance on stereo.

ATTACK One of the most important properties of a loudspeaker is its ability to reproduce sharp percussive sounds without blurring or hangover. This property is known technically as transient response but is often referred to as attack.

The qualities conducive to good attack are:

1. Wide frequency response;
2. Low coloration;
3. Adequate electro-magnetic damping from good magnets (in moving coil speakers);
4. Properly designed enclosures or methods of mounting;
5. Good amplifier with reasonable damping factor.

(See also Transients.)

ATTENUATION A reduction of amplitude or signal strength.

AUDIO Derived from the Latin *audire*, to hear, the word audio is now used to refer to the general science and industry of sound reproduction.

The effective audio range covers about nine octaves, say 30 to 18,000 c/s, but nobody has perfect ears and we all hear at levels which vary according to frequency.

Although some pipe organs go down to 16 c/s, the lowest notes are felt more than heard and it does not matter if you press the wrong pedal below about 25 c/s unless the stop is coupled to another in a higher register. Bottom A on the piano is 27.5 c/s but contains little fundamental; most of what you hear is in the harmonics at 55 c/s, 82.5 c/s, 110 c/s and so on. In records, things begin to fall away below 40 c/s and you would need a very special type of magnifying glass to find anything worth having below 30 c/s.

At the other end of the scale, harmonics of musical sounds may go very high in frequency, but level response to about 15 kc/s is adequate for life-like results.

In some hi-fi circles it is customary to talk about frequency response of 20 to 20,000 cycles, which is about ten octaves. This may be necessary in amplifiers and other items of equipment, but is out of reach acoustically under average working conditions.

AUDIO FAIRS The first B.S.R.A. Exhibition held in the St. Ermin's Hotel, London, on Saturday and Sunday, May 29th and 30th, 1948, at which fifteen firms exhibited, could fairly be described as the first-ever Audio Fair.

In America, the first Audio Fair was in the New Yorker Hotel on October 27th, 28th and 29th, 1949. There are now about forty Audio Fairs a year being held in America, but we are limited to one main show per annum in London, and one in the north.

Attendances at these demonstrations show no signs of falling off and it is a reasonable assumption that they will be with us for a few more years. Fortunately, there is less "sound and fury" than there used to be.

AUDITORY PERSPECTIVE The impression of spaciousness and depth which can sometimes be achieved using single channel equipment by skilful microphone technique and studio design, but more convincingly done by stereo.

AUTO-TRANSFORMER A transformer in which a portion of the winding is common to both primary and secondary circuits. This type of winding may be used for loudspeaker matching transformers and for mains voltage and adjustment, e.g. between 240 v and 117 v, for which a circuit is given in Fig. A/7.

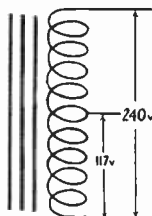

FIG. A/7.
Auto-transformer for ac mains
240 v to 117 v.
Core—3" × 2½" × 1".
Turns—2400, tapped at 1200.
Wire—32 swg enamelled copper.

AXIS In a moving coil loudspeaker the principal axis is an imaginary line passing through the apex of the cone at right angles to its base. At high frequencies most of the radiated energy is concentrated in a narrow beam along the axis, and it is therefore customary to take frequency response curves with the measuring microphone located somewhere along it. In order to assess the change in directivity with frequency it is useful to consider other response curves taken with the microphone placed at 30°, 45° or 60° off axis.

AZIMUTH This term was originally used in astronomical measurement. In tape reproduction it refers to the angle between the planes of the recording and reproducing head gaps relative to the direction of tape travel. It is essential for the azimuth to be zero in order to minimize high frequency losses in reproduction. (See Alignment.)

B

B.A.F. Bonded acetate fibre. A type of absorbent wadding made from crimped cellulose acetate fibre bonded with a plasticizer. It is an excellent acoustic absorbent and thermal insulator. It is light in weight and clean to handle, and is therefore becoming widely used for lining loudspeaker enclosures as well as in architectural acoustics and heat control. Some idea of its properties may be gleaned from the tests with circular columns described in Section C.

The makers of B.A.F. are Southalls (Birmingham) Ltd., Industrial Division, Charford Mills, Saltley, Birmingham 8, from whom supplies may be obtained.

B.B.C. British Broadcasting Corporation. Formed in 1927 from the earlier British Broadcasting Company. Must be numbered among the most responsible and culturally sensitive broadcasting organisations in the world.

B.R.E.M.A. British Radio Equipment Manufacturers' Association. Address: 49 Russell Square, London W.C.1.

B.S.R.A. British Sound Recording Association. Run by amateurs, this association is interested in all aspects of the art of recording and reproducing sound.

Monthly lectures are arranged during the winter months at the Royal Society of Arts, John Adam St., London, usually on a Friday evening.

The Hon. Secretary is Mr. S. W. Stevens-Stratten, 40 Fairfield Way, Ewell, Surrey.

The B.S.R.A. Journal is published quarterly, and the address of the Editor, Mr. J. W. Godfrey, is Friends Bungalow, Long Sutton, Langfort, Somerset.

BACK EMF When a conductor moves in a magnetic field so as to cut magnetic lines of force, an electromotive force is induced in the conductor in such a sense that, if a current is allowed to flow, the secondary magnetic field so created around the conductor will be in opposition to the primary field. This is known as Lenz's Law.

In other words, if a coil of wire immersed in a magnetic field is used to generate motion (motor action) the coil cannot escape having a voltage induced in it by generator action. The induced voltage will push against or back off the driving voltage and is therefore known as the back emf.

The effect of the back emf is to produce an apparent increase in the impedance of the coil since less current is passed for a given applied voltage. The greater the velocity attained by the coil, the greater will be the back emf and the higher its apparent or motional impedance. This is clearly demonstrated by the increase in impedance of a moving coil loudspeaker in the region of its fundamental resonance where the voice coil is moving rapidly. The impedance peak is due entirely to back emf, and shows up as a rise in voltage which may be largely absorbed by adequate electro-magnetic damping.

BACKGROUND NOISE A combination of unwanted random noises which may accompany recorded or broadcast programmes, but are today very well controlled in good equipment. The worst offender—needle scratch—has been virtually eliminated by the use of suitable plastics for producing discs. (A lecture on the development of recording given by Mullards a year or two ago was neatly and aptly entitled “Starting From Scratch.”)

BAFFLES One of the first methods of mounting a moving coil speaker was to use an open baffle, and there is still a lot to be said in its favour, absence of enclosure resonance and use of sound from both sides of the cone being the main benefits.

Wall mounting gives a true infinite baffle, but limits the sound in one room to the output from one side of the cone. Small total enclosures are sometimes referred to as infinite baffles but this is a misnomer. The smaller you go with such enclosures, the more sound absorbents you must pack into the box, and this proves there is something wrong.

In theory, the distance across a baffle must be half a wavelength to avoid cancellation effects, but in practice, floor and wall reflections in ordinary rooms help to improve LF performance, and mounting two or more speakers in parallel and in the same plane has a similar effect.

The avoidance of panel resonance is just as important with open baffles as it is with other forms of mounting.

The whole subject of baffle mounting was thoroughly investigated in the 5th Edition of *Loudspeakers*. See Piano Chart for baffle size related to frequency.

BALANCED ARMATURE This loudspeaker driving system was extensively used 28/30 years ago. It

consisted of a horseshoe magnet, a reed with push-pull operation surrounded by a coil, and a cone or diaphragm attached to one end of the reed. Its days were numbered as soon as the moving coil design appeared on the market.

BASILAR MEMBRANE A part of the human hearing mechanism which analyses sound into its various components.

BASS The general meaning is deep-sounding. A bass voice covers a fundamental frequency range of 90 to 300 c/s; a bass tuba and a double bass range from about 40 to 380 c/s. The lowest portable instrument is the double bassoon, 33 to 350 c/s. The bottom note on a piano is A at 27.5 c/s, and some organs go down to 16 cycles.

It is difficult to specify what the real bass frequency range actually covers. Middle C on a piano is 261 c/s and hardly sounds like bass to the ear, so perhaps we could start an octave lower and say 130 cycles downwards, which is roughly the bottom two octaves.

In sound reproduction, most of the bass we hear comes in the octave around 65 to 130 c/s. To reproduce this fully with a single loudspeaker on an open baffle suspended in free air (i.e. not touching floor, walls or ceiling) a baffle diameter of about 8 ft. would be required. From this, it is logical to conclude that the average radio set or portable record player produces little or no real bass unless hitched up to a bigger speaker system. Fortunately, all the bass notes in music contain harmonics, and the human ear helps to replace the missing fundamental, so our table sets never sound quite as bass-less as they really are.

Records. In records, the bass is well maintained down to about 40 c/s, but it is generally agreed that there is not much worth worrying about below that frequency, which incidentally has a wavelength of 28 ft. If you can reproduce the bottom note of a double bass properly, you are not doing badly.

Small Enclosures. During recent years the bass output from rather small cabinets (less than 2 cu.ft. in volume) has been improved by adopting units having very low fundamental resonances and fitted with more linear suspension systems which allow large cone excursions without audible distortion.

With larger reflex or horn loaded systems, the loudspeaker receives a great deal of help at low frequencies, and a little distortion from non-linearity in the suspension is often swamped by the reinforced fundamental. In the new compact systems, the unit has to do all the work virtually unaided, necessitating large linear excursions with freedom from air leaks through the surround or panel joints.

Most of the compact systems use 12" loudspeakers, but smaller units can be employed if reduced acoustic power output is

acceptable. An 8" unit with bass resonance around 30 c/s would be difficult to make and in a small enclosure would have to attain enormous voice coil velocity to reproduce 30 cycles at the same level as a bigger unit or bigger enclosure.

For easy reproduction of good bass, the old maxim "the bigger, the better" still applies, within reason.

BEAM EFFECTS Most loudspeakers are very directional at high frequencies, and when the sound waves shoot out in a straight line they produce beam effects, which annoy some ears more than others. Methods of spreading the beam include the Slot Diffuser and the Acoustic Lens. A simple remedy is to face the offending speaker upwards or at an angle so that the sound is reflected from wall or corner.

BEATS When two sounds are heard which differ only slightly in frequency, the ear can detect the difference frequency as a cyclic variation in amplitude. These amplitude pulses or beats add greatly to the richness of musical sounds, but they are also put to practical use in the tuning of instruments, since the speed of the beats indicates the spacing between two nearly identical notes. Laboratory oscillators are tuned in a similar manner by allowing the output signal to beat with a small voltage, derived from the ac mains, shown on a meter.

BEL The logarithmic ratio between two acoustic or electrical powers, so named after the inventor of the telephone—Alexander Graham Bell, 1847–1922. Because one complete bel is a big change, it is usually more convenient to work in decibels. As the name implies, a decibel is one-tenth of a bel.

BIAS, H.F. In tape recording it is essential to apply magnetic bias to the recording medium along with the signal in order to avoid the harmonic distortion which would otherwise result due to inherent non-linearity of the magnetic material. The application of bias also greatly increases the sensitivity of the recording process.

In all but the cheapest machines high frequency bias is employed by feeding the recording head simultaneously with the required signal and a supersonic current usually between 30 and 100 kc/s. The recorded noise level can be affected by the shape of the bias waveform, and the strength of bias should be adjusted for optimum results with each type of tape. This is always carried out in professional work, but domestic machines are set at a compromise value.

BIFILAR A method of transformer construction in which the primary and secondary turns are wound side by side, turn for turn. This technique ensures very close coupling between windings and can be safely used when high voltages are not developed between primary and secondary.

BIMORPH Literally means two shapes, and is applied to an assembly of two piezo-electric crystals used to generate signals when subjected to mechanical-deformation. There are two main types, benders and twisters. The latter are sometimes called torsion bimorphs. Both types of assembly can be used in the construction of pickups and microphones. Ceramics are bender bimorphs and are being used more and more for stereo pickups.

BINAURAL Listening with two ears. Sometimes wrongly applied to stereophonic recording and reproduction. All normal hearing is binaural, irrespective of whether the programme material is mono or stereo.

BLUMLEIN, A.D. Alan Dower Blumlein was probably the greatest genius ever known in this country in the field of electro-acoustics.

We are indebted to Mr. H. A. M. Clark, Technical Director, Records and International Division, E.M.I. Ltd., for his assistance in drawing up the following brief summary of Blumlein's career, Mr. Clark having enjoyed—as he puts it—the privilege of working with him from the date he joined E.M.I. to the time of his tragic death.

Blumlein was born in 1903 and after his education at Highgate School and the City and Guilds College of Engineering in London, he joined the Standard Telephone Company and was engaged in telephone engineering. He made most valuable contributions in connection with the loading of long-distance telephone cables and to the technique of measurements used.

He joined the Columbia Graphophone Company in 1929 and among his early inventions was a moving coil disc cutter in which the damping was applied electrically. Similar principles were applied to a moving coil microphone resulting in an electric recording system having a wider frequency range and lower distortion than those in general use at that time. After the formation of Electric & Musical Industries Limited, his developments in electric recording were adopted by the group. By 1934 he was actively engaged on the development of a fully electronic system of television and he was largely responsible for the specification of the standards of the E.M.I. television system which was adopted by the B.B.C. and which has formed the basis of the British 405 line system with hardly any modifications.

In his short working life he took out well over a hundred patents, some of them covering such important inventions as the slot aerial, the ultra linear output stage, the use of inductively coupled ratio-arms in measuring bridges, and some very advanced ideas in the application of negative feedback.

His contributions to the war effort included automatic ranging circuits in fighter interception radar and many features of the blind bombing equipment known as H₂S and it was in connection with this work that he was involved in a fatal air-crash in June, 1942.

Among his many inventions covering a wide field of activity, the most famous today is British Patent Specification No. 394,325, dated 1931, which describes in detail a system of stereo recording and reproduction.

This amazing document deals with microphone pickup techniques, film recording methods, and the design of cutter heads and pickups for single groove stereo discs, and even means of transmitting stereo signals by radio.

Blumlein stated that "it is preferred not to cut one track as lateral cut and the other as hill and dale, but to cut them as two tracks whose movement axes lie at 45° to the wax surface, or at some convenient angle dependent on the relative available intensities from lateral cut and hill and dale respectively."

Thus A. D. Blumlein foreshadowed 45/45 stereo discs twenty-five years before they made their commercial debut. In commenting on this Patent in the April, 1958, issue of the *Journal of the Audio Engineering Society of America*, the Editor said: "When it is realised that many of the ideas, psychoacoustic, mechanical and electrical, set forth in this document of 1931 are only now gaining wide, popular currency, one may well reflect on the magnitude of the economic forces which control the viability of inventions."

BREAKUP A term used to describe the condition in a loudspeaker when the diaphragm does not move in phase with the driving force over its entire surface. This fault attends all loudspeakers in some degree but is most common in the cheaper brands of paper cone, moving coil types, where breakup resonances may be introduced deliberately to increase the sound output at the expense of smoothness and give an impression of greater sensitivity.

When breakup occurs some areas of the cone move with higher velocity than others, and may even move in opposition to the sense of the voice coil. This is illustrated by the two photographs in Fig. B/1 where the lycopodium dust has moved away from the high velocity areas and collected along the nodal lines.

Poor transient response and blurred results with the production of sub-harmonics usually attend breakup resonances. Proper choice of cone textures and shape, with soft edge termination, help to keep the disease under control.

The theory that a speaker system with all the cones limited to piston action should give excellent results has often been propounded. We made a test a few years ago and came out with a 5-way system embracing 15", 10", 8", 5" and 3" units, with a 5-way crossover network containing more than a dozen coils and capaci-

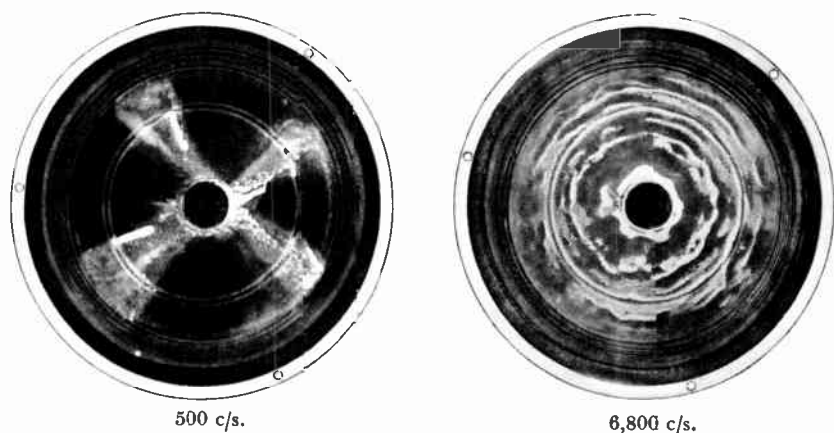

FIG. B/1. Illustrations of cone breakup.

tors. After careful listening tests, it was decided that the benefits of piston action were not easily recognised and the cost and intricacy of the dividing networks outweighed any breakup effects from a more normal 2- or 3-way system. (It is sound economy to remember that the more inductors and capacitors you put into a crossover network, the more power is thrown away.)

BRICK ENCLOSURE For optimum LF results with almost any loudspeaker, a corner enclosure is hard to beat, and if built of bricks or concrete all structural resonance is avoided. This in turn avoids absorption of energy at very low frequencies, and the absence of coloration at middle frequencies improves transient response.

The response curve in Fig. B/2 shows that even an 8" unit will maintain a good level of output down to about 40 c/s when given the necessary backing, an achievement which is impossible on a small scale.

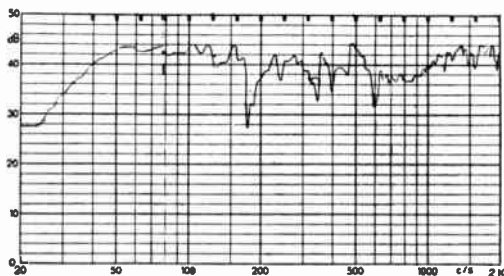

FIG. B/2. Response of 8" unit in 9 cu.ft. corner brick enclosure. Cone resonance 52 c/s. Input 1 watt.

Thanks to stereo, smaller, portable cabinet models are being widely used, as few rooms can be equipped with a couple of corner speakers at a reasonable distance apart, but the brick design is repeated here for the benefit of those who may still be interested in optimum results from at least one system. An arrangement for separate 8" middle and 3" top speakers is included in the diagram.

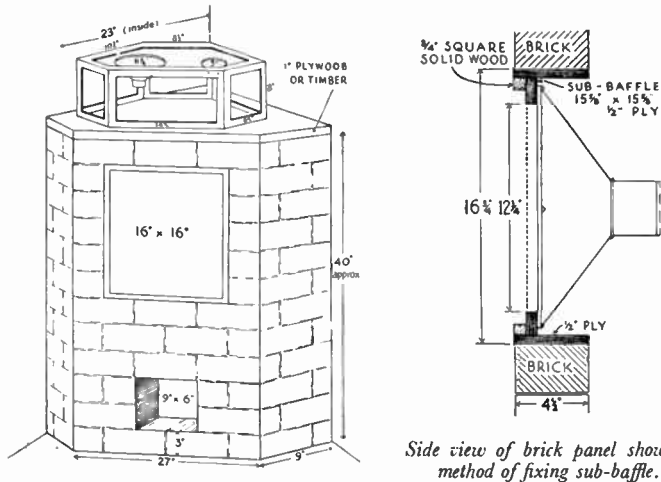

FIG. B/3. Brick corner enclosure, 9 cu.ft., used with no interior lining or absorbers.

According to our cartoonist, domestic differences of opinion about such enclosures existed in olden days.



I THINK IT SOUNDED BETTER WITHOUT
THE CAVE

FIG. B/4.

Early experiments.

C

C.B.C. Canadian Broadcasting Corporation.

C.B.S. Columbia Broadcasting System, Inc. (U.S.A.).

C.C.I.R. Comité Consultatif International des Radiocommunications, Palais Wilson, Geneva, Switzerland.

The C.C.I.R. is the radio consultative committee of the I.T.U. (International Telecommunication Union) of the same address. It was established in 1927 to study technical and related questions concerning international radio communication and to give its opinion on those questions.

CRT Cathode ray tube. A large evacuated envelope, usually of glass, fitted with a means of generating and focusing a narrow beam of electrons onto an internal fluorescent screen. Cathode ray tubes are employed in television, radar and oscillography.

CABINET Anybody who reads this book already knows what a radio or loudspeaker cabinet is, but I did look the word up in the Oxford and in Chambers's to see if an apt description could be found. The best was "case for keeping valuables or displaying curiosities".

The subject is far too big to be tackled in a digest. Many books are available and most loudspeaker makers in England and America supply cabinet construction sheets free of charge to suit their models.

Separate cabinets designed to obtain maximum results from a loudspeaker are now the order of the day in the high quality market. Many radiograms are beautiful pieces of furniture, but you can't have it both ways and the *only* scientific way to design a loudspeaker enclosure is to put acoustic requirements first and appearance second.

Stereo has made independent speaker enclosures an even more pressing need, as optimum results are impossible if single cabinet compromise is indulged in. Two speakers 6 to 8 ft. apart are the ideal in the average living room.

During the last two or three years great progress has been made in the design of small enclosures up to about 2 cu.ft. in volume. Excellent bass response down to 30 c/s can now be obtained, and the popularity of such models for stereo is understandable and reasonable. The fact remains that bigger models still give better results. (I rarely ride in a Rolls-Royce, but whenever I do I find it superior to the latest and most cleverly designed 10 h.p. car which, however, is easier to park.)

CANTILEVER In a general sense a cantilever is a rigid arm supported at one end, the other end being free to move.

The device is often used in pickups, usually crystal or ceramic types, but also in some of the modern moving coil and moving magnet models designed for stereo. The stylus is attached to the free end of a thin rod, or strip of metal or plastic, the other end actuating the voltage generating elements, the main purpose of the cantilever being to reduce the mechanical impedance at the stylus.

The schematics of Fig. C/1 show three applications of the system in stereo pickups.

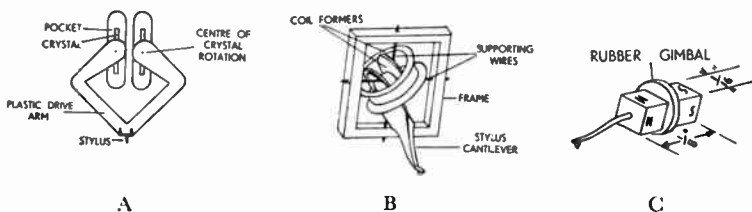

FIG. C/1. Cantilevers in stereo pickups.

A—Crystal.

B—Moving coil.

C—Moving Magnet.

Early loudspeakers such as the moving iron and balanced armature types also used the cantilever principle, but reed resonances were prominent and movement was unduly restricted. In pickups, the cantilever strip can be made to supply the necessary compliance and also to transmit the stylus vibrations faithfully and uniformly over a wide frequency range without introducing resonances.

CAPACITANCE (Capacity.) The ability of a capacitor or condenser to store electrical energy. Electrostatic capacitance is measured in farads. (See Farad.)

CAPACITOR An assembly of conducting plates separated by an insulator (called the dielectric) which possesses electrostatic capacitance. Still referred to in conversational terms as a condenser.

CARDIOID See Microphone.

CARTRIDGE The head of a pickup containing the voltage generating mechanism and stylus assembly, which

clips on or plugs in to the tone arm.

CASSETTE Known also as tape cartridge or magazine, this replaces the two separate reels normally used on tape recorders, the machines being specially designed for single loading with the cassette. Although the nuisance of tape threading is avoided, the facilities of editing are also largely sacrificed.

Just as $3\frac{3}{4}$ " /sec cassettes were showing signs of settling down in the market, a new $1\frac{7}{8}$ " /sec system was announced in America (see under Tape Recorders) and the future is again clouded in glorious uncertainty.

CATHODE FOLLOWER A valve amplifying circuit in which the load is included in the cathode circuit instead of the anode, as is more common.

Important characteristics of the cathode follower are its high input impedance and low output impedance. It can therefore be used as an impedance transforming or matching device. The gain or amplification is usually slightly less than unity. (This is a bit of technical jargon meaning that there isn't any gain, but there is usually a loss. Speaking commercially, the cathode follower is a non-profit making concern.)

Cathode followers are used with condenser and crystal microphones which require high input impedance. They are often employed to couple separate preamplifiers and main amplifiers via long lengths of cable at low impedance.

CAVITY RESONANCE If a loudspeaker is mounted behind a very thick panel, as at A in Fig. C/1A, sound wave reflections across the opening will produce cavity resonance. This effect can be avoided by mounting the speaker as at B.

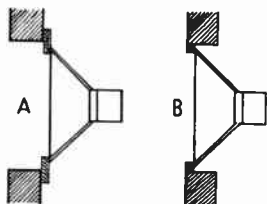

FIG. C/1A. To avoid cavity resonance use arrangement B.

The resonance effects are negligible if the length of the pipe is less than about one-tenth of its diameter.

The main cavity resonance occurs where the wavelength is approximately equal to the circumference of the cavity. Thus, with a 10" loudspeaker fitted to an aperture of $8\frac{1}{2}$ " dia. the resonance will occur around 500 c/s, but its effect will be negligible if the depth of the cavity is less than $\frac{7}{8}$ ".

Similar effects arise with microphones, but naturally at much higher frequencies.

You can easily make a test by speaking through a pipe or tube a few inches long. Obviously, the longer and narrower the tube, the more devastating are the effects.

CENTIGRADE Temperature scale widely used in scientific work and normally used on the continent. Derived from the Latin *centum* a hundred, and *gradus* step, it was first used in Celsius's thermometer, and places the freezing point of water at 0° and boiling at 100°.

To convert degrees centigrade to fahrenheit multiply by 9, divide by 5, and add 32°, or easier still, used the following table. Intermediate values are found by adding 5° or 0.5° to centigrade against 9° or 0.9° to fahrenheit.

TEMPERATURE TABLE

	Centigrade	Fahrenheit
Freezing point	0°	32°
	10°	50°
Normal room, G.B.	18.33°	65°
" " U.S.A.	21.1°	70°
Heat wave, G.B.	30°	86°
Human body	36.9°	98.4°
Heat wave, U.S.A.	40°	104°
" " India	50°	122°
	60°	140°
	70°	158°
	80°	176°
	90°	194°
Boiling point of water at sea level ...	100°	212°

CENTRING DEVICE Used in moving coil loudspeakers to prevent the coil fouling the sides of the magnet gap, and also to help to maintain the correct elevation when the coil is at rest. A perfect specimen would be seen and not heard, and would have infinite axial but no lateral flexibility. There is no such device, although designers have been trying hard to produce one during the last thirty years. It is difficult to increase flexibility without losing horizontal control.

CERAMIC Originally pertaining to pottery, this word now has wider applications in the field of audio. Many years ago we made an old kitchen sink into a loudspeaker enclosure with excellent results acoustically, but appearance and weight militated against its popularity.

Ceramic magnets made of barium ferrite material can be pressed and sintered to exact shapes and have been widely used for cathode ray focusing, cycle dynamo magnets, door catches, etc. Larger ring type ceramic magnets are also being developed for loudspeakers.

In pickups and microphones bender bimorphs of lead zirconate are known as ceramic, and are not so easily affected by heat and humidity as the long established Rochelle Salt units.

CHANNEL SEPARATION In recording and reproducing stereo, some of the information from the left-hand channel is inevitably reproduced in the right-hand channel and vice versa. The amount of cross modulation or cross-talk between channels varies with frequency and also with the type of equipment in use.

With tape it is not difficult to achieve channel separation in excess of 40 dB over the greater part of the frequency range although this is usually reduced at very high frequencies. With 45/45 discs the position is not so good because it is difficult to design a pickup to give better separation than 25 dB at middle frequencies diminishing to 10 dB or less at each end of the scale. Possible variations are pictured in Figs. C/2 and C/3.

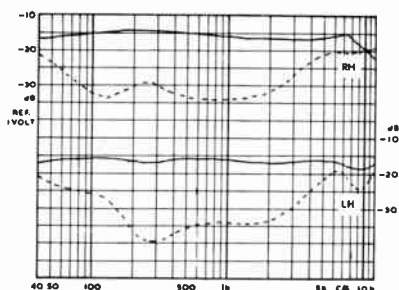

FIG. C/2. Typical response curves and separation between channels of crystal pickup.

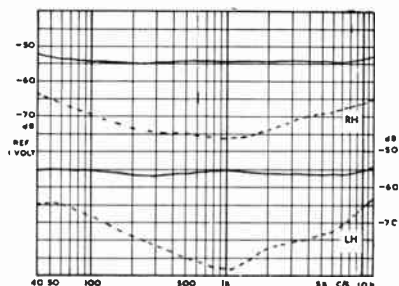

FIG. C/3. Good separation producing clean results, with full stereophonic "spread".

The minimum cross-talk figure for good stereo has still to be established. Cross modulation exists within the human head itself due to bone conduction and it has been suggested that it may not be worth while trying to achieve a system separation in advance of the normal physiological limits. Meanwhile, designers of stereo pickups continue to reduce cross modulation as much as possible at all frequencies.

CHASSIS Known in some countries as cone housings, cradles or baskets, the LS chassis is used to maintain the position of the cone, to anchor the centring device, and to carry the magnet.

Usually made in pressed steel or die-cast aluminium alloys, the tool charges are high for both types, but in the final product the die-casting is much more expensive, and is usually superior in rigidity and open construction which avoid resonance, loss of shape, and "boxed-in" tone colour.

CHATTER When the 400/500 headings for this book were being drawn up and allocated, I noticed that our Technical Editor had put my initials against Chatter. Ignoring the compliment, I will explain that the term usually refers to needle chatter in pickups and is due to the mechanical vibration of the moving parts, and the record surface, which occurs with some pickups more than others. It has been stated that the absence of audible chatter proves that the stylus is maintaining perfect contact with the groove, but this is hardly the case, as it depends more on the physical dimensions of the moving parts and the amount of damping applied to them.

In moving coil speakers, loose turns in the voice coil will vibrate on their own and produce "chatter".

CHOKER See Inductor.

CLIPPING When an amplifier is operated at high volume close to its maximum power handling capacity the highest peaks in the programme will be cut off if the input signal drives the amplifying circuits beyond their overload point.

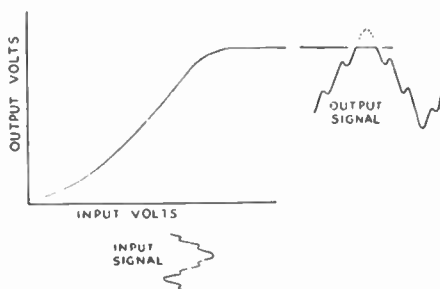

FIG. C/4.

Peak clipping when amplifier is overloaded.

Moderate peak clipping does not cause serious audible distortion in a properly designed amplifier but there will be some roughness and hardening of tone quality. Distortion will be noticed however with poor quality amplifiers which produce parasitic oscillations when overloaded.

Distortionless methods of peak clipping are deliberately employed in broadcasting to protect high power transmitters from accidental overload.

COAXIAL This word is normally used to describe a loudspeaker built with a large gap for LF and a small one for HF, provided with flux from a common magnet. Thus a wide range model can be produced in the one chassis.

COBALT A metallic element used in the composition of many permanent magnet alloys. It is now one of the world's strategic materials costing about £1,200 per ton today, compared with £2,070 some five years ago.

Just in case the reader is interested in speculating in important metals, we have dug out the following current quotations for comparison with cobalt:

Aluminium	£186 per ton
Copper	£248 " "
Nickel	£600 " "
Tin	£784 " "
Tungsten...	£1,600 " "

(Personally, I would rather have 1,046 $\frac{2}{3}$ Savings Certificates than a ton of tin.)

COCHLEA The inner ear comprising the mechanism which detects and analyses sound.

COERCIVE FORCE The magnetomotive force required to reduce the remanent magnetism in a permanent magnet to zero.

The diagram shows a typical magnetisation or BH curve. The remanent magnetism is B_r and the coercive force required to fully demagnetise the specimen is H_c .

FIG. C/5.
Typical magnetisation
or BH curve.

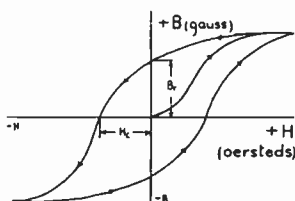

COERCIVITY Strictly speaking coercivity is the same thing as coercive force but by common usage is now associated with magnetic tape rather than permanent magnets. In magnetic tape, coercivity is an important factor in determining high frequency response since high coercivity resists the self demagnetisation effects which become more serious as frequency

goes up or as tape speed is reduced. Unfortunately, high coercivity tapes demand higher recording and bias currents and are very difficult to erase. Older types of tape recorder will often fail to completely eliminate an unwanted recording and a bulk eraser must then be used.

COLUMAX A super grade of permanent magnet material similar to Alcomax but possessing a higher degree of grain orientation. It is very expensive and is used where high performance magnets are required with minimum size and weight.

COLUMN SPEAKERS Fitted with a suitable 8" or 10" unit, a column gives remarkable results when judged on a cost *v.* performance *v.* floor space basis.

Many listeners have found columns satisfactory for stereo because they give virtually omni-directional results and work well with a different type on the other channel provided it is not too directional.

Having recently devoted quite a lot of time (and energy when on sewer pipes) to the testing of column loading, we are reporting fully on our findings.

Design Data. The basic requirements for good results with reasonable dimensions are as follows:

1. Cone area must be considerably less than the cross-sectional area of the column, to ensure reasonable air loading.
2. The panels and corners of any column structure must be rigid to avoid resonance. Concrete gives excellent results but interferes with mobility.
3. An oblong shape is better than a square (even when playing Rock 'n' Roll) but square is better than circular.
4. The whole enclosure must be airtight apart from the vent (or vents) which should be fairly near the floor for maximum radiation at low frequencies.
5. An acoustic filter inserted about one-third of the way up helps to reduce harmonic resonance and improves rigidity in plywood types.
6. In rectangular columns, the portion above the filter should be lined with 1" thick wadding or B.A.F. to reduce reflection effects. In a circular pipe, a roll of wadding should be inserted above *and* below the filter in place of the simple lining, to impede sound reflections and make up for reduced volume of air loading. (A square pipe 12" \times 12" and 3 ft. long gives 3 cu.ft. but a 12" dia. circular shape gives only 2.35 cu.ft.)
7. As the loudspeaker faces upwards, a cone-shaped diffuser should be fitted to disperse the treble horizontally, say 4" dia. with 8" units, or 6" dia. for 10" speakers. This section of the column

above the loudspeaker should be fitted with an open grille or mesh to avoid "boxed in" tonal effects.

8. Lengthening a column lowers the frequency of the harmonics, but if a height of $4/5$ ft. is reached the sound is rather loftily radiated, and has a disintegrated effect if the vent is placed near the floor for maximum bass radiation.

For these reasons, we prefer columns of moderate height, with acoustic effects dealt with by adequate cross-sectional area and internal treatment.

DESIGNS

Constructional details for various columns for use with 8" and 10" units now follow.

Satisfactory results with 10" units can be obtained by increasing the dimensions of 8" models by 20/25%.

Results with 12" speakers are disappointing unless abnormally large pipes or columns are used, when the economy of space no longer applies. More conventional forms of mounting are therefore recommended for 12" units. (Columns for 15" models are out of the question.)

PLYWOOD COLUMN

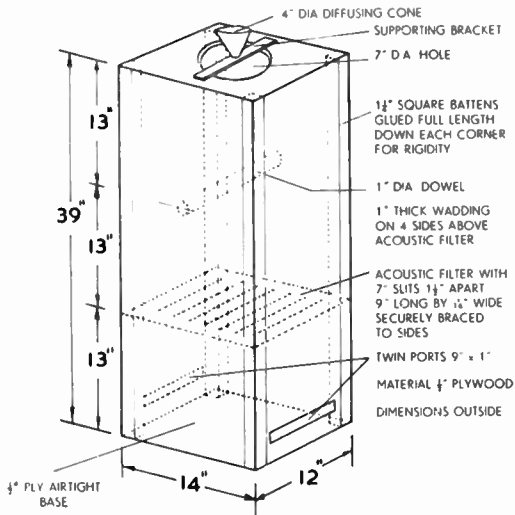

FIG. C/6. Plywood column (with solid wood corners) for 8" unit. Weight 30 lb. approx. Internal volume 3 cu.-ft. approx. The dowel must be tightly wedged between the two panels to control resonance.

CONCRETE COLUMN

The results here are superior to those obtained from the previous figure.

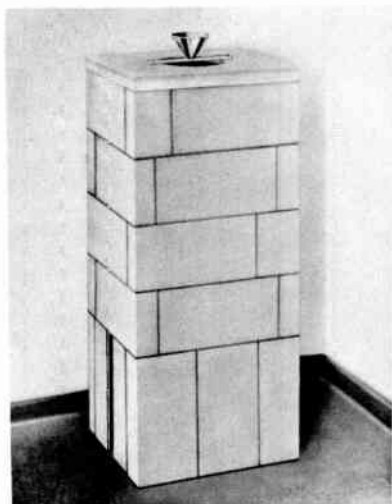

FIG. C/7.

*Concrete column,
approx. 3 cu. ft.
Twin ports 12" × 1"
or single
opening 12" × 2".
Dimensions:
Inside 13" × 11".
Outside 17" × 15".
Height 3 ft.*

The coloured concrete blocks measure 12" × 6" × 2", weigh 10½ lb. each, and are obtainable from builders' merchants. The entire structure weighs about 2½ cwt.; but if fitted to brick wall or corner up to 50% of the blocks can be omitted and the twin ports arranged to clear the skirting-board.

A column 36" high is satisfactory with an acoustic filter inserted one-third of the way up.

The acoustic filter should be as specified for the wooden column.

The baffle on which the speaker is mounted must make an airtight fit to the top of the column, which is lined with 1" absorbent material above the filter.

The finished column is easily painted or papered to match the walls of the room, or may be covered by thin plywood panels.

THINNER SLABS

In some districts the 12" × 6" × 2" slabs are not easily obtainable, but thinner and smaller ones may be. A diagram using slabs 9" × 6" × 1½" is outlined in Fig. C/8. This gives about 4 cu.ft. internal volume and is suitable for 8" or 10" units.

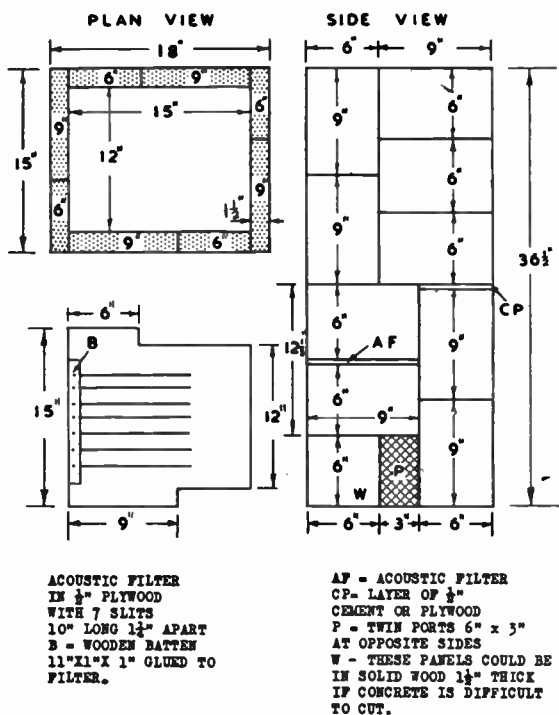

FIG. C/8. Concrete column, 4 cu.ft., using slabs 9" x 6" x $\frac{1}{2}$ " and suitable for 8" and 10" units.

CIRCULAR COLUMNS

Drain Pipes. Those who wish to avoid the heavy building operations associated with concrete slabs, and also to have a movable assembly, may turn to ready-made sewer pipes as illustrated in the following figures. We have bought the 8" model from local builders' merchants at 12s.6d, and the 10" model at about 25s.

Results are not so good as with the rectangular slabs because the internal volume is less and the circular shape is acoustically poorer, but the two rolls of wadding help to produce satisfactory performance. See Figs. C/9 and C/10.

A larger pipe is pictured in Fig. C/11. This gives very good results with a suitable 10" unit.

(If the pipe is turned upside down, a 12" unit can be fitted in the wide section but this is not recommended as results are unsatisfactory.)

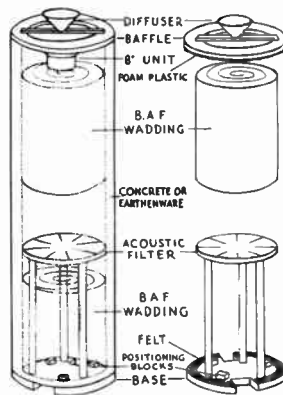

FIG. C/10.

Details of components.

FIG. C/9. *Exterior and interior views of porous concrete drain pipe assembly for 8" unit. 1.3 cu.ft. Height 3 ft. Dimensions: 11" outside dia., 9" inside dia. Weight 106 lb. Two vents 3" × ¾" in base, or one 3" × 1½".*

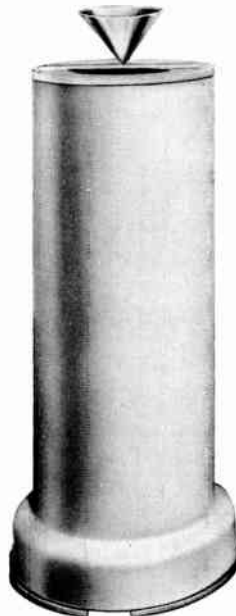

FIG. C/11.

Drain pipe for 10" speaker, giving about 2.5 cu.ft. in volume. Height 3' 3".

Dimensions:

12" inside dia.

14½" outside dia.

Weight about 145 lb.

Two vents in base, 3" × ¾" or one 3" × 1½".

One of the odd things about columns is that the bass often sounds better than it really is, and the need for a separate tweeter may be felt, more so with 10" units than 8". A convenient method of mounting is shown in Fig. C/12. The speakers are connected in parallel with 4 Mfd isolating capacitor for the treble unit.

FIG. C/12.

Column with two speakers.

T = Tweeter.
D = Diffuser.

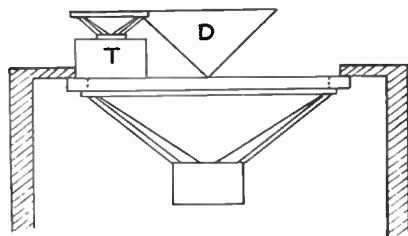

Column mounting is suitable for the home constructor; results with 8" and 10" units can be very good, and the cost with concrete models is extremely low. It should however be pointed out that these columns do not give the pure bass down to 30 c/s which is possible with 12" roll surround units in specially designed enclosures of about 2 cu. ft.

Acoustic Treatment. The following motional impedance curves show the effect of interior treatment on the rather small pipe of Fig. C/9 which, although 3 ft. tall, gives only 1.3 cu.ft. of air loading and produces an audible honk around 250 c/s when untreated. This is shown at A in Fig. C/13. The insertion of an acoustic filter improved things slightly as at B, and two rolls of wadding had the smoothing effect shown at C. Reproduction of both speech and music was improved. The rise at 100 c/s, due to the bass resonance of the system, is also reduced, but this is less objectionable than coloration at 250 c/s and is actually partly absorbed by damping factor of amplifier.

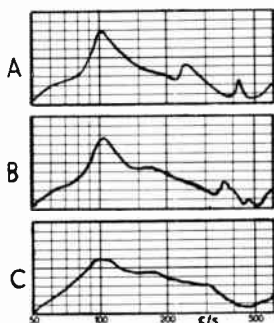

FIG. C/13.

Motional impedance curves. 8" unit in circular pipe 9" inside dia. 3 ft. high.

A = no internal fittings.

B = with acoustic filter.

C = with filter and two rolls of B.A.F. absorbent.

COMPACTRON This is the name given to a new electronic device developed in America with a view to replacing conventional valves and transistors in radio and TV sets and gramophones.

According to a report in *The Financial Times*, June 30th, 1960: ". . . the Compactron is only in pilot production at present but plans have been made to start mass production in the autumn.

"General Electric claims that the device will yield impressive savings in both space and cost and says that in a radio receiver two Compactrons will be equivalent to five conventional valves or seven transistors; in a TV receiver ten Compactrons would equal 15 valves plus three diodes or 24 transistors plus 11 diodes. The device resembles a conventional valve, but is smaller and has more functions.

"The company expects to produce Compactrons at prices below those of conventional valves and well below those of the more expensive transistors. No date has been announced for the marketing of the first Compactron TV or radio sets but it is expected that some will be on the market within a year.

"It is understood that the Compactron is not suitable for exacting tasks as would be required in military electronic equipment or computers."

N.B. Another micro-miniature device by Westinghouse is described under Molecular.

COMPATIBILITY The advent of stereo has brought this word into common use.

If a stereo pickup can be used on mono records, it is compatible. This can usually be done, but with some new discs and many old ones, the fine 0.5 mil point goes too far down into the groove and scrapes the bottom instead of resting on the sides. Some people keep a spare head with 1 mil stylus; others keep a good mono head for playing mono records.

According to Cecil Watts in the June 1960 issue of *Hi-Fi News* there is a variation in groove radius even in the new stereo discs and a counsel of perfection would be to have three sizes of styli on hand: 0.5, 0.75, and 1 mil respectively, to cope with different makes of record! Perhaps the best compromise is to plump for 0.75 mil radius and use it on the lot.

Conversely, a stereo record is not compatible with the usual mono pickup which is lacking in vertical compliance and soon does some damage if used on stereo discs. (It would be quite simple to produce a mono pickup *with* vertical compliance.)

A compatible record, meaning one with reduced vertical modulation to be played by ordinary mono pickups as well as the more compliant stereo types, would ease the stock situation, but it is difficult to see how this could be done without unduly degrading the stereo information in the groove.

In broadcasting, any multiplex stereo system which is adopted must be compatible, which means that single-channel listeners should obtain reasonably good results from stereo programmes. (Many years will elapse before the majority of listeners are converted to stereo—if ever.)

COMPENSATOR Name given to the small plug-in units supplied with some of the more expensive preamplifiers for accurate matching to a variety of pickups and other programme sources, in terms of impedance and sensitivity. Use of the correct type often makes a big difference to results.

COMPLIANCE The inverse of stiffness. The yielding quality of the members which suspend the moving parts of a pickup or loudspeaker. For a given mass of moving parts, the higher the compliance, the lower the fundamental resonance of the system.

In loudspeakers, high compliance in suspension is a main objective to lower the fundamental resonance and avoid frequency doubling.

CONCERT HALLS The control of reverberation time and sound dispersal by acoustic engineers and archi-



FIG. C/14. *The Concert Hall, Broadcasting House, London, showing organ console, announcer's chair, pianos and various microphones, with organ grille behind centre clock.*

pects in modern concert halls has added much to the pleasure of listening, both for concert goers and indirect listeners.

Modern halls have been built in Europe, Canada, America—in fact, one is to be found in most of the large cities of the world today.

The various photographs kindly sent to us by the B.B.C. give a good idea of the sort of acoustic treatment which may be applied. The Concert Hall at Broadcasting House is very well known, and the No. 3 Studio at Maida Vale is the source of many of the excellent concerts of light music which are broadcast with such technical perfection.

The No. 1 Studio at Maida Vale is also an acoustic fairyland. I have attended a concert there with Mr. Cooke and found it a rewarding experience. There are only four rows of seats in the balcony, but tickets for concerts can frequently be obtained from the B.B.C. and are worth the trouble that may be necessary to obtain them.



FIG. C/15. *Maida Vale Studio 3, showing acoustic curtains in background and absorbent panels of special shape on side walls and ceiling. The wooden panelling near the floor provides low frequency absorption. Note baffle mounted talk-back speaker on the left.*

The next three photographs were all taken at Maida Vale. At the concert already mentioned, the main item was a Mozart



FIG. C/16. *Maida Vale Studio 1. General view showing orchestra platforms and choir seating, with plain ceiling at this end to aid reflection.*



FIG. C/17. *Maida Vale Studio 1. Excellent view of ceiling showing variation in size and shape of scattering elements. Note also boxes on side walls which act as acoustic absorbers and diffusers, with special treatment of wall behind small balcony where audience is accommodated.*

piano concerto and the piano was placed so that the sound was reflected from the lid towards the microphone and away from the audience in the balcony. The dispersal of sound was so good that I noticed no ill effects from listening to a piano the wrong way round.



FIG. C/18. *Maida Vale Studio 1. Back wall showing dispersive treatment and organ grilles. Part of the permanent choir seating is also shown.*

Concert-going. Naturally, we must continue to go to live concerts if we wish to keep our hearing fresh. I recently heard a performance of Mahler's Symphony No. 6 in the Royal Festival Hall. This is a work with a huge dynamic range (hard to reach in radio or records!) and uses all the resources of a very large orchestra.

I was forcibly impressed by three things. First, the enormous acoustic volume put out by such an orchestra. Second, the clarity which is retained in the hall, down to a single tap on the big drum when all the other instruments are being played; and third, some harshness in the tone of the brasses which is no doubt the price to be paid for the dry acoustics which provide the clarity in such a large auditorium. The Royal Albert Hall or Carnegie Hall would be kinder but less precise.

Had we played a record in the R.F.H. in a similar way, many listeners would have complained that it was too loud and strident.

Just as motor cars tend to deprive us of the benefits of walking, so home listening tends to divorce our ears from the real thing in concerts.

CONDENSER An older term for capacitor, *q.v.*

CONE The majority of moving coil loudspeakers are fitted with a cone for passing on the sound vibrations to the air, because a cone shape gives maximum rigidity for a given size and weight of diaphragm. The main exception is the tweeter arrangement of Fig. C/19, which works well over a limited frequency range.

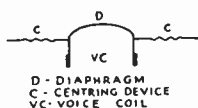

FIG. C/19.
Coneless tweeter.

The range may be extended downwards by horn loading.

The cone is popular because the size, shape, weight, texture, suspension and method of centring can be varied in hundreds of ways to suit requirements. All these affect performance in one way or another.

Cone diameter is usually 20/25% less than outside chassis diameter of the speaker. The shape may be circular or elliptical, with straight sides or a curvilinear flare (in which case it is not really a cone at all!).

The texture may be fine and hard for good HF response, or thick and soft, containing pure wool, for smooth middle and bass output.

Methods of suspension at periphery, and centring around apex, are very important, especially in small enclosures where efforts are made to get a quart of bass out of a pint of space.

The main virtue of a cone is that it moves as a piston over a few octaves, depending mainly on its size. As all cone-type loudspeakers less than 12" diameter are subject to purchase tax in G.B., anybody who can invent an 8" or 10" coneless type which works properly is in the money. A saving of £2 or £3 tax on a 10" unit would appeal to buyers even in Scotland or Yorkshire.

CONSTANT AMPLITUDE In disc recording the condition in which signals of equal intensity are cut with constant lateral amplitude irrespective of frequency. Crystal and ceramic pickups are also said to be constant amplitude types because their output voltage is proportional to amplitude of stylus movement as distinct from velocity, unless internally compensated.

CONSTANT CURRENT If a loudspeaker or recording head is driven by amplifier with very high internal impedance, the output *current* will be substantially independent of impedance variations in the load. This arrangement is useful in tape recorders where the recording head is usually operated under constant current conditions to avoid the attenuation which would otherwise result from its rising impedance at high frequencies.

Loudspeaker response curves are sometimes taken under conditions of constant current but this method is gradually giving way to constant voltage measurements which agree more closely with practical conditions of use, most amplifiers having a low internal impedance with NFB.

CONSTANT VELOCITY In disc recording, the condition in which signals of equal intensity are cut with constant lateral velocity irrespective of frequency. Magnetic and moving coil pickups are also said to be constant velocity types because their output voltage is proportional to stylus velocity.

CONSTANT VOLTAGE If a loudspeaker is driven by an amplifier having a very low internal impedance (say one-tenth of the nominal impedance of the speaker, giving a damping factor of 10) the output *voltage* will remain substantially independent of impedance variations in the load. This will avoid a rise in voltage across the loudspeaker terminals at the resonance frequencies of the system, thereby giving a smoother response especially at low frequencies. Unfortunately, the same process applies at high frequencies where the inductance of the voice coil produces a rising impedance, and there is some attenuation of HF response. This effect can be counteracted by the use of aluminium voice coils and other means of improving HF output.

CONSUMER REPORTS There is a lot to be said in favour of the testing of consumer goods by impartial bodies, followed by unbiased reports on value, performance and reliability, provided such tests are made by men with some practical experience, and not purely by technicians.

For example, we have seen consumer reports on loudspeakers which ignored flux density and magnets completely; but the magnet is the part that costs the most money, so how can value be assessed fairly if the magnet is overlooked? One can only assume that the back-room boys who made the tests were labouring under a delusion that magnets grow on trees. (Ask Sheffield!)

In another case, gramophone turntables were criticised for some most peculiar and erudite reasons, but their habit of disseminating varying fields of hum was overlooked, probably because the tests were made with a pickup which was insensitive to hum. But some excellent stereo pickups *are* sensitive to hum, and a user should select a turntable with a low stray field. The consumer reports in question might well lead him astray.

Finally, how can these panels of judges decide what is the best buy? Let us assume that you and I are both looking for a pair of loudspeakers for use on stereo. Your listening room is 35 ft. × 24 ft., but mine is only 14 ft. × 10 ft. The best buy for you might be unsuitable for me, and vice versa.

As we said at the beginning, consumer reports are very useful provided you also exercise your own judgment when buying, and remember that it takes two years to find out what any product will be like after two years of use. No laboratory can do it by accelerated tests in two days.

CORE Material used to increase the permeability of the magnetic circuit surrounding an inductor or transformer. For audio frequencies the core is usually composed of thin laminations stamped from sheets of silicon steel or high nickel alloy. The laminations are electrically insulated from each other to reduce eddy current losses.

Other types of core include C cores manufactured from a continuous strip of grain orientated material and dust cores made by bonding small particles of magnetic material with synthetic resin.

CORNER ENCLOSURE This arrangement usually gives very good LF performance for the following reasons:

1. The walls, if solidly built, form an excellent backing at no cost and give a triangular shape to the enclosure.
2. The speaker faces the longest length of the room and this helps in LF reproduction.
3. The corner is normally the least resonant part of the floor.

CORNER HORN The advantages outlined for enclosures are augmented with horn loading by using the walls to increase the effective mouth area, thus improving LF performance and lowering the cut-off frequency.

Pioneers in the design of corner horns have been Paul Voigt in

this country and Paul Klipsch in the U.S.A., the identity of Christian name being merely coincidental and fortuitous.

COUPLING When energy is transferred from one circuit or mechanism to another, coupling exists between them. Thus, if two coils are so arranged that the magnetic field from one cuts the turns of the other, they are coupled. Similarly, if two loudspeakers are mounted close together so that the sound field created by one joins up with or affects the behaviour of the other, they are coupled.

Great use is made of coupling effects in electronics and acoustics, but, occasionally, unwanted coupling causes trouble as in acoustic feedback; hum pickup from gramophone motors; amplifiers suffering from parasitic oscillation, a.s.o.

CROSSOVER NETWORK Known also as dividing networks or separators, these devices consist of inductors, capacitors, and possibly resistors, for dividing the output of an audio amplifier into various frequency bands to feed two or more separate loudspeaker units.

The basic principle is quite simple. HF is attenuated by capacitance in parallel or inductance in series with the voice coil. LF is attenuated by reversing the procedure. Resistance attenuates at all audio frequencies. A simple crossover network can easily be designed by reference to the reactance values listed under R.

A selection of useful networks is given in Fig. C/20.

Crossover Frequency. The component values are in inverse proportion to the frequency. Therefore, to cross over at 500 cycles instead of 1,000 multiply all C and L values by 2. To cross over at 2,000 cycles instead of 1,000, divide all C and L values by 2.

Impedance Values. The values shown in circuits NW1 to NW6 are for 15Ω speakers. To arrive at values for higher and lower impedances proceed as follows:—

30Ω circuit, divide all C values by 2;
multiply all L values by 2.
7.5Ω circuit, multiply all C values by 2;
divide all L values by 2.

In other words, as the circuit impedance is doubled the L values are also doubled but the C values are halved.

Therefore, taking circuits NW4 and NW6 and crossing over at 400 c/s, we arrive at the following values, which are near enough for all practical purposes.

	400 c/s at	3Ω	7.5Ω	15Ω
NW4	C=	120	60	30 Mfd
	L=	1.5	3	6 mH
NW6	C=	64	32	16 Mfd
	L=	2	4	8 mH

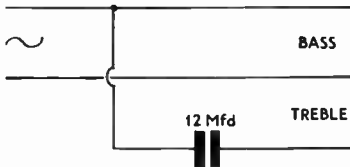

N.W.1. Simple high-pass filter

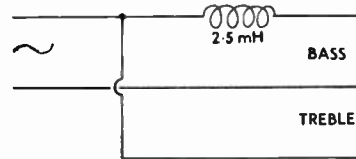

N.W.2. Simple low-pass filter

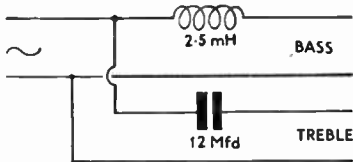

N.W.3. Quarter Section, Parallel

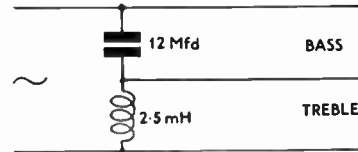

N.W.4. Quarter Section, Series

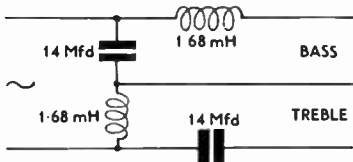

N.W.5. Half Section, Series

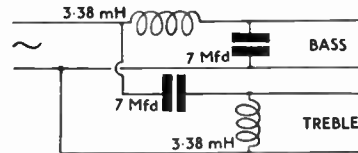

N.W.6. Half Section, Parallel

N.W.9. Half Section, 3-speaker circuit.
Crossover at 800 and 5,000 c/s.N.W.10. Quarter Section, 3-speaker circuit.
Crossover at 1,000 and 5,000 c/s.

FIG. C/20. Typical Constant Resistance Crossover Circuits with values for 15 ohms speakers and 1,000 c/s crossover, except NW9 which is for 800 and 5,000 c/s and includes two volume controls.

CROSS-TALK See Channel Separation.

CRYSTAL Certain materials exhibit the property of generating a potential difference or voltage between opposite faces of a suitably shaped piece when subjected to mechanical deformation. Conversely they will be deformed under conditions of electrical stress. This phenomenon is known as piezo-electricity and is found in a wide variety of substances of which the most important is Rochelle Salt. Crystals of this material

can be grown on a large scale for cutting and assembly into bimorph elements used in the construction of crystal pickups and microphones.

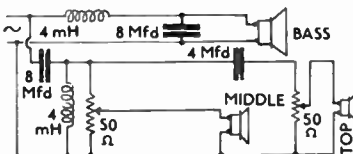
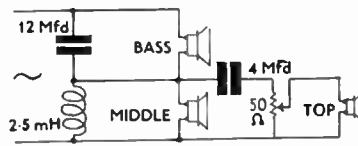
These devices have played an important rôle in the economic development of domestic sound reproduction. The crystal pickup has the unique virtues of high output and low cost, and requires little or no frequency correction.

Similarly, the majority of low-priced microphones used with domestic tape recorders are crystal types.

The modern crystal device is robust and reliable but is permanently damaged by temperatures above 55°C (130°F).

CUBIC MEASURE

	<i>cu.in.</i>	<i>cu.ft.</i>	<i>U.S.g.</i>	<i>Imp.g.</i>	<i>cu.metre</i>	<i>British fluid oz.</i>
1 cu.in. ...	1	—	0.0043	0.0036	0.000016	0.5773
1 cu.ft. ...	1728	1	7.48	6.234	0.0283	997.6
1 U.S. gallon ...	231	0.1336	1	0.833	0.003785	133.4
1 Imp. gallon ...	277.3	0.1604	1.200	1	0.004543	160.1
1 Brit. fl.oz. ...	1.732	0.001	0.007	0.008	0.000028	1
1 cu.metre ...	61,020	35	264	220	1	35,210

CURRENT A flow of electrons through a conducting medium constitutes an electric current. The cgs unit is the ampère. (In case the reader is interested, cgs is a system of units based on distance, mass and time, measured in centimetres, grammes and seconds.)

CURRENT FEEDBACK See NFB.

CUTTER HEAD An electrically-driven cutting tool used for engraving lacquer discs when transferring master recordings from tape to disc. The cutter itself is usually of sapphire or diamond attached to a soft iron armature and driven by electromagnetic forces, and is shaped like a chisel.

CYCLES PER SECOND Usually abbreviated to cps in America and c/s over here, this is a measure of the rate of vibration in a sound wave, which determines pitch.

In electricity, it relates to the number of times alternating current changes from positive to negative in a second; usually 50 cycles here and 60 cycles in America.

Many turntables and tape recorders are driven by synchronous motors and depend on mains frequency for speed and, therefore, the pitch of reproduced music. The accuracy of the mains is now adequate for all ordinary purposes, thanks to the high standards set by the Electricity Board. Any variation in frequency during peak hours of load is adjusted every 24 hours, so that electric clocks keep remarkably accurate time.

When playing records or tapes in the ordinary way, a slight change of pitch is of no consequence as not one listener in a thousand can detect it; but if synchronising with live organ or piano playing is attempted, then absolute uniformity of pitch is essential and some form of speed control may be necessary to cope with possible variations in pitch of recording as well as reproduction.

CYLINDER RECORD The forerunner of the modern gramophone was the phonograph, invented by Thomas A. Edison in 1877. In its commercial form, the phonograph played a cylindrical record $4\frac{1}{8}$ " long with an outside diameter of $2\frac{3}{16}$ ", and recorded with hill and dale modulation in a spiral groove.

The circular flat disc recording was invented by Emil Berliner in 1888 and lateral modulation was used. Although technically less perfect than the cylinder type due to slower surface speed as the needle approached the centre of the record, the flat disc won the day because of easier production and storage, greater convenience in use and two-sided operation.

D

dBm The power of a signal expressed in decibels with a reference level of 1 milliwatt. Thus a power of 100 milliwatts may be described as 20 dBm.

DC Direct current. Although most audio equipment requires dc, it is more convenient to have ac mains and use a transformer to give the necessary voltages and then rectify to dc. Practically all public electricity services are now ac, but I recall that in 1933, when we began to make loudspeakers in Bradford, we had dc mains and so we did not have to buy a costly magnetising plant. We simply wound a large coil and connected it through a heavy switch to the corporation electricity supply. This gave us enough current to stop the trams, but the engineers from the supply station were soon on our track demanding to know why we kept on shorting the mains! A control circuit limiting our surge to about 50 amps solved the problem.

DAMPING The process of absorbing energy by mechanical friction or electrical resistance to reduce the amplitude of vibrations or oscillations.

Examples which spring to mind are panel resonance in loudspeakers, and room resonance. Both can mar the reproduction of music, and yet the methods for subduing them appear to be contradictory.

Panel resonance in speaker enclosures is damped by sandfilling or cross-bracing and may be avoided by using heavy and rigid construction in concrete or bricks.

Room resonances or eigentones are subdued by using damped resonant panels which absorb energy at suitable frequencies.

The difference lies in the fact that panel resonance is the disease in the loudspeaker and it colours the reproduction as well as absorbing energy in the process.

In room acoustics, the eigentones are the disease but the sound pressure is not high enough to cause the absorbent panel to vibrate so much as to colour the reproduction.

DAMPING FACTOR This is the ratio of the nominal load impedance to the internal impedance of an amplifier. Thus, with a 15 ohm speaker and an amplifier with 1 ohm internal impedance (due to NFB) the damping factor is said to be 15, but as the loudspeaker impedance varies with frequency the damping factor must do likewise.

A good damping factor is useful in absorbing resonance, but the electric resistance of the voice coil is in series with the output, so there is little point in advancing the damping factor beyond about 10. Fig. D/1 shows how the effective damping factor varies with amplifier damping.

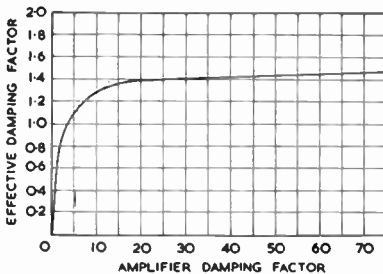

FIG. D/1.

Effect of amplifier output impedance on loudspeaker damping. Nominal load impedance = 15 ohms. DC resistance of voice coil = 10 ohms.

DEAD SPOTS In acoustics these are positions, usually inside a building, where large obstacles or reflecting surfaces produce areas of weak sound pressure, and they may occur under balconies or galleries in theatres.

The only real cure involves structural alterations, but some improvement may be obtained with a well designed P.A. system and suitably placed loudspeakers.

In a very big theatre, placing small loudspeakers in dead spots a long way from the stage may make confusion worse confounded because of the time-lag between the reproduced sound and the voices on the stage, unless an electrical delay system is introduced.

DEAFNESS According to official figures, there are 600,000 deaf people in Great Britain using National Health *Medresco* hearing aids. In addition, there are very many who use commercial aids costing anything up to £100. (A very good review of hearing aids appeared in the July, 1960, issue of *Which?*)

Deafness varies, of course, enormously in degree and in frequency range affected, the HF region usually falling off with advancing age. Naturally, vocal range tends to be affected in a similar way. I remember a Chinese soprano who was getting on in years and was having difficulty with her top notes. She met an old friend and remarked: "Long time no C."

Speaking personally for a minute, I am not blessed with the gift of perfect pitch, yet I can place a pure tone at around 13,000 c/s within 2½% because my hearing goes out like a light at 13,500 c/s, which is, incidentally, rather high for my age. (Once you pass the 60 mark, you cannot complain if you lose an octave every ten years.)

The following two illustrations show the sensitivity of good ears over the audio range, and the effect of the most common form of deafness, which usually operates in the upper registers.

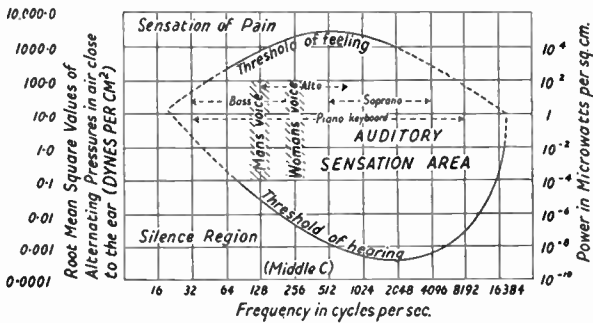

From *Wave Motion and Sound* by Stephens and Bate. Arnold.

FIG. D/2. Working limits of the ear for pure tones.

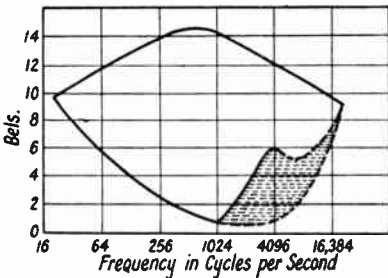

FIG. D/3.

Auditory chart of a person deaf to high frequencies.

Also from *Wave Motion and Sound*.

So far as audio is concerned, slight deafness in one ear or both does not disqualify a listener as a judge of good reproduction. This depends on tonal discrimination and memory.

Local background noise and reverberation are probably the worst enemies for the deaf when listening to reproduced sound. Directional loudspeakers are often a help, but headphones are the most complete answer as they eliminate both forms of interference.

For a report on total deafness in one ear see sub-title *Binaural Effects* under EAR.

DECIBEL or dB. One-tenth of a bel.

DE-EMPHASIS Inverse of Pre-emphasis *q.v.*

DELAYED FREQUENCY RESPONSE When the input to a loudspeaker is suddenly interrupted, the sound output does not cease immediately but decays comparatively slowly and in a somewhat irregular fashion over a period which may last as long as 50 milliseconds. The decay time varies considerably with frequency and with type of unit.

Complex methods of plotting and analysing decay characteristics have been investigated notably by D.E.L. Shorter and B.T.H. in England, and R.C.A. in America. An excellent three-dimensional delayed frequency response characteristic is illustrated in Fig. D/4. This shows the presence of peaks or resonances in the delayed response which do not appear as significant in the steady state curve and these are thought to account for the differences in coloration which are evident between two units having similar steady state response curves.

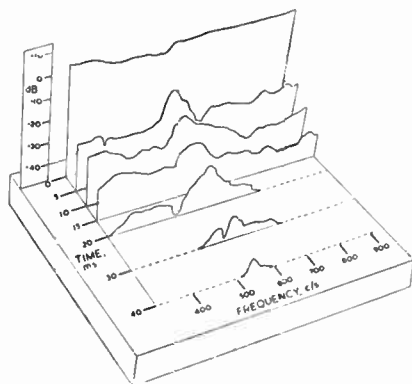

FIG. D/4. Interrupted tone test of loudspeaker. The rear portion represents the steady state response, and the others indicate different resonances which show up at intervals up to 40 milliseconds after termination of signal.

Reproduced by permission of B.B.C. and I.E.E.

The article from which this illustration is taken appeared in the I.E.E. Journal, Vol. 105, No. 24, Nov. 1958, written by D. E. L. Shorter and entitled *A Survey of Performance Criteria and Design Considerations for high-quality Monitoring Loudspeakers*.

These tests confirm the value of listening to a loudspeaker in order to make a final assessment of its performance, in preference to relying on the normal response curve.

DEMAGNETISATION After long use, the record/replay head of a tape recorder may become permanently magnetised. When this occurs, the noise level goes up with some loss of high frequencies, and recordings are liable to be permanently affected. Heads can be depolarised by the use of an instrument like the Wearite Defluxer costing 50s.

For bulk demagnetising or erasing of reels of tape, the reel should be inserted into a strong ac field. Many degaussers are commercially available at prices ranging from about 30s. to £15. Thorough erasure in a good device often gives better results than those possible with the erase head of the average tape recorder.

DENSITY In considering the suitability of various materials for avoiding panel resonance in loudspeaker cabinets, the safest guide is density, although the area and thickness of a panel also play an important part.

The density of some forty materials is given in the following table. The figure for air is 0.00122, and if you are interested in chloroform after making a cabinet and listening to results, the density is 1.5.

Material		Density in gm/cc.	Material	
Cork25	Marble	...
Celotex32	Granite	...
Pine45	Aluminium	...
Walnut56	Quartz	...
Beech65	Slate	...
Mahogany67	Mazak, cast	...
Plywood67	Nickel	...
Maple68	Zinc	...
Oak72	Tin	...
Weyroc81	Steel	...
Paper	...	1.0	Iron	...
Cellulose acetate	...	1.3	Brass	...
Dry Sand	...	1.5	Copper	...
Shellac	...	1.7	Cadmium	...
Beryllium	...	1.8	Cobalt	...
Brick	...	1.8	Silver	...
Tiles	...	2.0	Lead	...
Glass	...	2.4	Tungsten	...
Porcelain	...	2.4	Gold	...
Concrete	...	2.6	Platinum	...

One of the lightest modern materials is expanded polystyrene with a density of about 0.02.

DETECTOR A device or circuit used in broadcast reception to remove the carrier frequency and retain the modulation information. It is sometimes called a demodulator.

DEVIATION In FM broadcasting the frequency of the carrier wave is varied in sympathy with the modulating signal, the deviation of the carrier from its mean frequency representing loudness. The maximum deviation equivalent to 100% modulation is 75 kc/s (probably less in Russia).

DIFFERENCE TONE A combination tone formed when two signals beat together. Its frequency is equal to the difference between the two generating tones ($f_1 - f_2$).

In musical sounds, the harmonics or overtones are multiples of the fundamental frequency and there can be little doubt that these difference tones help the ear to replace some of the missing fundamentals when listening to small scale reproduction.

You can easily make a listening test by going to the piano and thumping at C 65.4 c/s (octave above bottom C) and the next G 98 c/s, with the sustaining pedal depressed. Then hold the two keys down and release the pedal. In addition to the two notes you will hear (I hope) some of the pitch of bottom C at about 32 cycles, which is the difference tone between your C and G.

Combination tones also include summation tones ($f_1 + f_2$) and were explained by Helmholtz as being due to the asymmetric vibrations of the ear drum.

DIFFRACTION This is the change in the direction of propagation of a sound wave caused by an obstacle in its path. The longer the wavelength of the sound compared with the dimensions of the obstacle, the greater is the diffraction effect.

At high frequencies, diffraction is poor. This is illustrated by the shadow produced by an object which obstructs rays of light.

Sound waves begin to bend round an object in their path when its dimensions are less than half a wavelength. Thus, if an easy chair about 2 ft. wide is placed in front of a loudspeaker—at a reasonable distance—there will be severe obstruction of frequencies above about 250 c/s but diffraction will improve as the frequency is lowered and extreme bass will be scarcely affected at all.

Microphones. Diffraction is of great importance in microphones intended to give a smooth performance at high frequencies. The wavelength of sound is only $\frac{7}{8}$ " at 15 kc/s, so a microphone case must be less than about $\frac{1}{2}$ " in size if sounds in the audio range are to diffract round it with the minimum disturbance of the sound field.

Diffusers. Diffraction may also be employed to spread the sound

in one plane by placing a slot diffuser in front of a loudspeaker. (See Directional Effects.)

Another method is to place a metal ball or cone near the apex of the speaker cone. An object 1" diameter will reduce beam effects above about 7 kc/s.

Although these devices can be proved to work, it is often difficult in ordinary rooms to notice their effect. After all, the sound has to come from somewhere, and it soon bounces off the walls.

DIPOLE In radio and television broadcasting a dipole aerial consists of two co-linear conducting rods or tubes of equal length, each being equivalent to one quarter of a wavelength at the frequency of operation. The complete aerial is therefore half a wavelength long and is referred to as a half-wave dipole. Such an aerial forms the basis of all the more complex types, and when used in conjunction with additional reflectors (behind the dipole) and directors (between dipole and transmitter) it becomes a Yagi array.

The term dipole has a slightly different meaning in acoustics where it refers to a pair of identical juxtaposed sound sources operating in anti-phase. A common example is a loudspeaker mounted on an open baffle. Such a sound source is characterised by a figure-of-eight radiation pattern.

DIRECTIONAL EFFECTS These become more pronounced as the frequency rises and wavelength is reduced.

Sound source is involved as well as distribution. A single source is no doubt the ideal for the human voice, but a wide source suits choral and orchestral works. The main thing is not to have middle and upper registers coming from the floor or ceiling; audio fountains and acoustic rain are not really natural phenomena.

Special Applications. Although strong directional effects in loudspeakers are usually frowned upon, they are sometimes very useful. Engineers go to a great deal of trouble in cinemas to arrange horn loading to direct the treble towards the entire audience, and in many "live" schoolrooms with large windows and no soft furnishings, directional or line source speakers reduce reverberation effects and improve intelligibility in the reproduction of speech. Such an arrangement projects the sound forward in a flat horizontal beam, the sound radiated to the sides and rear being considerably attenuated.

The radiation pattern down to frequencies as low as 100 c/s is indicated in Fig. D/5.

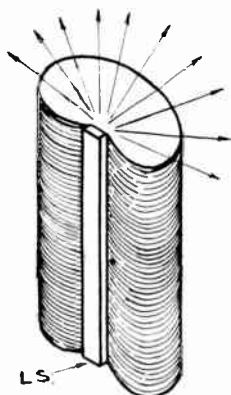
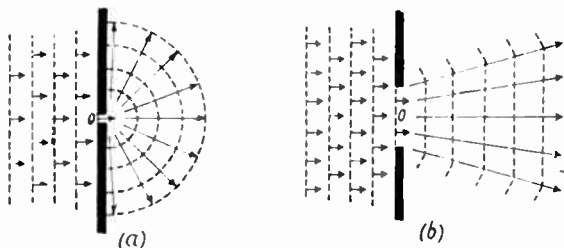

FIG. D/5. Free-hand drawing of radiation pattern of line source speaker, viewed from behind.

Slot Diffusers. The effect of passing HF sound waves through a narrow slot is neatly illustrated in Fig. D/6. In the first case (a) the width of the slot is less than the wavelength of the sound, but at (b) the width is greater.



From *Wave Motion and Sound* by Stephens and Bate. Arnold.

FIG. D/6. Sound waves passing through slot.
(a) Width of slot less than wavelength.
(b) Reverse order.

In practice, a slot 1" wide will answer for frequencies up to 13,500 c/s. The device is intended for use on treble speakers; there is a risk of cavity resonance if used with a full range model, and also obstruction of LF radiation which requires no first aid treatment for good diffusion.

Acoustic Lens. An acoustic lens is often fitted to horn-loaded tweeters to improve HF dispersion, as illustrated in Fig. D/7.

When a plane wave passes through the acoustic lens the parts of the wave nearest to the horn wall have to negotiate more perforated baffles than the centre of the wave. The outer surface of the wave

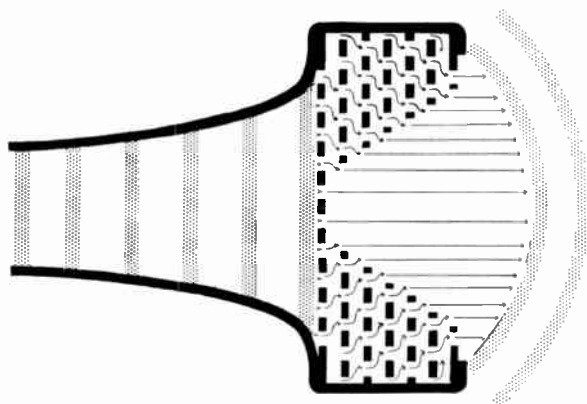

FIG. D/7. Sectional diagram of acoustic lens with perforated plates showing time-lag and wider dispersion.

is therefore delayed relative to the centre, and the wave front emerges with increased curvature.

DISCRIMINATOR A detector or demodulator for frequency modulated signals.

DISSIPATION The destruction or absorption of energy, usually in the form of heat. Achieving the correct amount is often an important consideration in the design of sound reproduction equipment. Too much dissipation is wasteful, whereas too little may allow unwanted resonances to develop.

As an example, the outer edge termination of a loudspeaker cone is designed to apply the right amount of dissipation to absorb high frequency energy and avoid it being reflected back into the cone—causing response irregularities. But at the same time the soft surround must help to keep the cone in place and to control the flexing which tends to occur if no support at all is given at the periphery.

In short, dissipation appears to be better for audio products than for their producers.

DISTORTION There are many forms of distortion in sound reproduction, as it covers any variation from the original. The main brands relate to:

1. Amplitude or non-linearity;
2. Frequency response;
3. Phase;
4. Scale;
5. Ambience.

Looking at these briefly, we might condemn or condone the faults as follows:

1. *Amplitude Distortion* is the most distressing and quite small amounts can produce very annoying audible results, especially where the higher harmonics are involved.

2. *Frequency Distortion* is not so objectionable unless fairly strong, as top cut is always preferable to slight HF distortion, but resonant peaks in reproduction soon irritate the sensitive ear, and booming bass cannot be excused on any pretext.

3. *Phase Distortion*. The ear is very tolerant here until considerable group delays are present. In view of the large amount of phase shift which occurs even in the best of amplifiers, distortion may be rather a strong word to use in relation to phase effects.

4. *Scale Distortion* occurs when a sound is not reproduced at its original volume, as heard, because the reproduced sound cannot then take account of changes in harmonic structure, reverberation and frequency response which would occur in nature. The reader can verify this by paying another visit to the piano and playing a note or a chord softly and then loudly, and listening for the stronger harmonics which are produced by the louder playing. It is obvious that a piano passage played softly originally and then reproduced loudly cannot sound right.

Perhaps the most common example is that of male speech, which sounds boomy and bass heavy when reproduced at an excessive volume level.

5. *Ambient Distortion* is now a common characteristic of the pop record in which artificial reverberation is applied *ad nauseam*. The young in heart and ear seem to like artificial reverberation but after fifteen minutes of it I require artificial respiration.

DIVIDING NETWORK See Crossover.

DOPPLER EFFECT The apparent change in pitch of a sound source which is moving relative to an observer. Everyday examples include the change in pitch of a fire engine bell as it approaches and then recedes in the opposite direction.

Some authorities ascribe importance to this phenomenon in connection with loudspeakers in which high and low frequencies are reproduced by a common cone assembly. Mathematical analysis shows that a type of frequency modulation distortion will be produced on the principal axis when large low frequency signals occur simultaneously with HF sounds, but in practice the amplitudes reached in domestic speakers are insufficient to cause audible effects.

DOUBLET This describes a loudspeaker which radiates sound forwards and backwards but not edgewise, the radiating pattern being similar to the pickup pattern of the figure-of-eight microphone illustrated at C in Fig. M/2. Typical examples are open baffles and full range electrostatics, which perform 75% as doublets when standing on the floor, or 50% if one edge is placed near a wall, so far as low frequencies are concerned.

Doublets are more susceptible to the effects of placement in listening room than are the more common types of loudspeaker known as direct radiators, which are virtually omni-directional at low frequencies.

DROP-OUT In tape recording, a decrease in output due to faults in the magnetic tape is known as a drop-out. Any lack of magnetic coating or inclusion of modules of foreign matter will obviously interfere with the recording process.

DUAL CONCENTRIC See Coaxial.

DUBBING Apart from its application to football boots, this word has three applications in sound. It refers to the copying of a recording by direct transfer; the super imposition of a commentary or other sounds to an existing recording; and in films to the making of an additional sound track in a different language.

DUMMY LOAD Used for convenience during testing. For instance, radio sets are usually fitted with dummy loads representing the aerial during alignment tests, and amplifiers are checked with a resistor to replace the normal loudspeaker, although it is not quite the same thing.

DUST BUG Invented by C. E. Watts, this is a device for cleaning records during the actual playing and consists of a brush and a pad which can be dabbed with anti-static fluid.

DYNAMIC RANGE The difference between the loudest and quietest passages in a programme. In broadcasting and recording, the quietest passages must always be rather louder than the background noise, whilst the loudest passages must be restrained so that they do not overload the equipment.

The dynamic range of a full orchestra may be about 75 dB, say between 30 and 110 dB. Records can accommodate a range of about 55 dB, which is quite impressive, but if you hear a full scale performance of a big symphonic work and then listen to a recorded or broadcast performance soon after, the loss in dynamic contrasts is most noticeable. This accounts for the impression of greater realism which is obtained from the reproduction of solos and small scale works in which little or no compression has been necessary.

It is not suggested here that dynamic range is unduly curtailed; avoiding distortion is far more important, and a reduction in peak volume levels also reduces the risk of annoying the neighbours!

DYNE The unit of force in the cgs system. A force of one pound weight is equivalent to 4.448×10^5 dynes. The internationally accepted value for gravitational force at sea level in latitude 45° is 980.62 dynes.

E

E.B.U. European Broadcasting Union. (Also known as U.E.R., Union Européenne de Radio-diffusion.)

Administrative Office: 1 rue de Varambè, Geneva, Switzerland.

Technical Centre: 32 avenue Albert Lancaster, Brussels, Belgium.

Receiving and Measuring Station: Jurbise-Masnuy (Hainaut), Belgium.

International Television Co-ordination Centre (Eurovision):

Palais de Justice, Brussels, Belgium.

International organization for the promotion of the study and interchange of information on all matters affecting sound and television broadcasting, the recommendation of standards for the European area, and the international exchange of programmes.

EHT Extra high tension. A term used to describe voltages above about 1,000 v.

EMF Electromotive force. The electrical pressure or tension between two points having differing electrical potentials. The practical unit of emf in the cgs system is the volt.

EAR The human ear consists of three compartments: the outer ear, leading through the ear-drum to the middle ear, which also contains air, and leads through the oval-window and round-window to the inner ear which contains liquid.

The main portion of the inner ear is the cochlea which contains the basilar membrane with some 30,000 fibres of varying length and tension used in our detection and analysis of sound. It is small wonder that no microphone ever approaches the delicacy and refinement of performance of the human ear.

The following book can be recommended to those who may be interested: *Theory of Hearing* by Wever, John Wiley & Sons Inc., New York; Chapman & Hall Ltd., London, 1949.

So far as audio is concerned, the astonishing thing about the ear is the variety of response. We all hear middle frequencies best (see Fig. D/2) but otherwise there are enormous differences between

us. Even so, the formant tones which give the tonal quality to instruments and voices seem to strike us all in a similar way; hence universal approval of a voice like that of Victoria de los Angeles or the oboe tone produced by Léon Goossens.

Binaural Effects. Since the advent of stereo, we have heard a lot about binaural listening and the ability to place a sound source and appreciate stereo effects. I find that closing one ear at a concert seems to reduce the volume level about 60% and pushes the orchestra back about 50 ft., but makes little difference to power of location.

After our last Festival Hall concert (May 1959) we received a large number of reports on the various items from members of the audience. The two extracts which follow are not without interest here.

From J.A.S., Hornchurch:

"I should explain that I am truly a 'monaural' listener, having lost the hearing in my right ear some years ago. My left ear is, however, quite normal and up to the standard for a man of my age (39).

"I have heard a number of stereo demonstrations at Audio Fairs and elsewhere and have, quite frankly, never been able to notice any real stereo effect, except' the usual train running from left to right, and have naturally put this down to my defective ear. But I *did* hear stereo on Saturday, though I am not sure, in view of the above remarks, whether you will consider my comments to be of any real value."

The comments which followed agreed in the main with our own views on the merits and shortcomings of the varied items, both mono and stereo, which made up the programme, and were read with great interest by recording engineers at EMI Studios, who had made the special mono, stereo test recordings.

The other letter was from A.H.U. of Aylesbury, who enjoyed the concert but has forthright opinions:

"Although I am almost totally deaf in one ear, my hearing extends above 15 kc/s in the other. Some people say that for this reason I will be unable to appreciate stereo. What rot! If it is possible to hear clearly a live performance it should be equally possible to appreciate stereo. It is not stereo gimmicks which are needed in high quality reproduction but the true sounds of musical instruments such as the breathy noise of the flute. This is audible enough in the concert hall but is rarely conveyed to recorded material. Volume compression and 'backing off' the percussion in any way results in unbalance, regardless of stereo."

It is clear from the foregoing that ears are rather like loudspeakers in that one good one is better than two poor ones, and the laws of listening have not been altered by stereo.

High Frequencies. It is well known that some animals can hear very high frequencies. A friend of mine who plays the mouth-organ informs me that, if he starts to play when his dog is in the room, this animal howls in apparent agony, but if Larry Adler is reproduced by loudspeaker the dog remains quiet and peaceful. "Why should this be so?" enquired my friend. Apart from suggesting that the dog obviously prefers Larry Adler's playing to that of its master, I think the explanation must be that there are very high harmonics in the harmonica which *we* cannot hear but which upset the dog, and these are missing in the reproduced sound, just as the "breathy" character is often missing in the reproduction of the flute; but here we must remember that to hear the various "noise" effects in an orchestra you have to be fairly close to it.

EARPHONE (or Headphone). A small transducer designed to work directly into the cavity of the human ear. In spite of the small diaphragm area, high resonance frequency and limited excursion, the stiffness of the ear cavity makes it possible to produce fairly clear fundamentals down to below 100 c/s provided that air leaks between the earphone and ear are avoided.

The main use of earphones is of course as telephone receivers, and the original design by Alexander Graham Bell is still in use with only minor modifications. A schematic with average response curve is given in Fig. E/1.

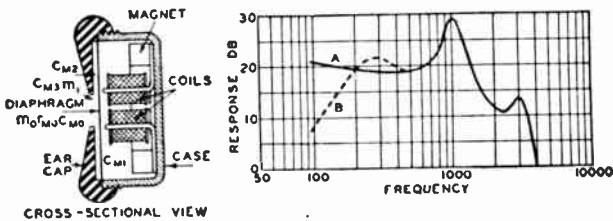

FIG. E/1. Diagram and response curve of magnetic earphone, taken from Olson's *Elements of Acoustical Engineering*.

A thin, soft iron, diaphragm is actuated by two coils of wire on the pole pieces of a permanent magnet. General purpose types cut off in the treble around 3,000 c/s. The main resonance usually occurs at about 1,000 c/s and produces the well known characteristic telephone tone, and also intensifies background noises and clicks.

Much better performance—at higher cost—is obtained from crystal and moving coil designs, which are used where serious monitoring or communication is involved. Typical response curves are shown in Fig. E/2.

Incidentally, the writer designed a moving coil headphone in 1936, complete with constant impedance volume control, as

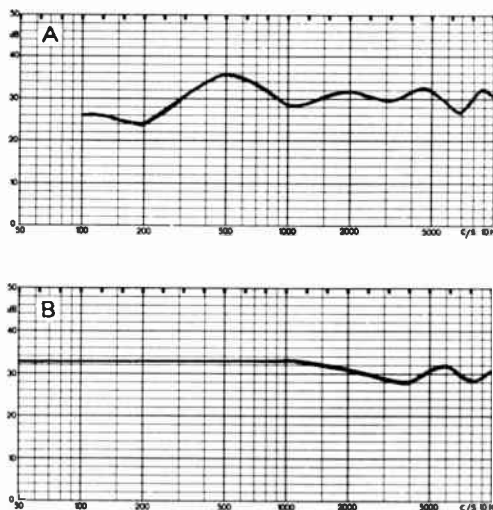

FIG. E/2.
 Typical response curves of earphones.
 A = crystal.
 B = moving coil.

illustrated in Fig. E/3. Although we have no evidence to prove that this was the first MC type to be produced and sold, we have seen no evidence to prove the contrary.



FIG. E/3.
 Moving coil headphone produced in 1937.

ECHO Sound repeated by reflection from a surface, with a time-lag of 0.05 sec. or more, which depends on the distance between the sound source and the reflector.

Continuous reflections of sound in enclosed spaces are known as reverberation (q.v.) and their effect on recordings is referred to as ambience.

An echo chamber is often used to add "life" to broadcasts and recordings made under "dead" conditions. A loudspeaker is placed in a very reverberant room with hard walls, and a microphone

picks up the sound which is then amplified, equalised, and fed back to the original recording channel through a mixer control at the required level, probably 20 dB below the level of the main channel.

A typical circuit with echo chamber is given in Fig. E/3A.

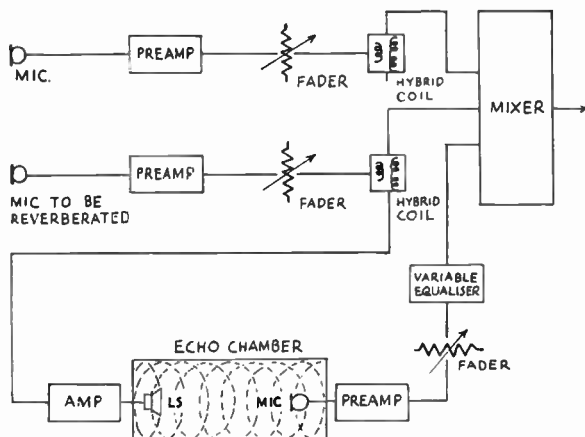

FIG. E/3A. Block diagram of recording channel with echo chamber.

Even in St. George's Hall, Bradford (which is considered by the natives to have very good acoustics!), a small, bare room is used as an echo chamber by B.B.C. engineers when broadcasts from the hall are in progress.

The hybrid coil shown in the diagram of Fig. E/3A is a special transformer with accurately balanced windings which is widely used in line transmission work.

EDDY CURRENT When a conductor is cut by magnetic lines of force the emf so induced will cause current to flow if the circuit is completed.

Such current flow can be a source of trouble and wasted power in transformers and motors where alternating magnetic fields produce eddy currents in the magnetic cores, which, if visible, would look like swirling water. These currents are reduced by using laminated cores with stampings insulated electrically from each other to increase the flow path resistance.

It is, however, possible to put the effect to useful work, as in eddy current brakes fitted to some variable speed transcription turntables.

EDISON, THOMAS ALVA (1847-1931) Born in Milan, Ohio, U.S.A., this inventive genius produced the first working gramophone, the electric lamp,

and a carbon microphone which enabled A. G. Bell to complete his telephone.

Edison undoubtedly captured public imagination around the turn of the century and was popularly known as the Wizard of Munro Park.

In addition to his inventive talents, he was well endowed with practical and commercial acumen, which the real genius rarely possesses. This is exemplified by the fact that large numbers of the phonographs which he made are still in working order after a span of nearly sixty years.

EFFICIENCY The ratio of work or energy delivered, to the energy put into a device. In audio equipment, efficiency varies widely from about 90% for a high grade transformer to between 5% and 15% for loudspeakers.

EIGENTONE Resonance produced by parallel walls in a room. The worst condition would be a cube as the resonance frequencies would be the same in all directions and would add severe coloration to reproduced music unless countered by room treatment.

The lowest resonance occurs at half a wavelength. Thus a room 14 ft. \times 14 ft. \times 14 ft. would have a strong eigentone at 40 c/s, with harmonics at 80 c/s and 120 c/s (plus diagonal resonances at 57 c/s, 70 c/s, etc.) because the wavelength of sound at 40 cycles is 28 ft. A similar effect is produced in loudspeaker enclosures, where the only shape worse than a cube is a globe or sphere, in which a large amount of absorbent material must be used to get rid of honking.

The best dimensions for a listening room would be in accordance with the Golden Ratio of 1 : 1.6 : 2.5 for height, width and length. With a height of 8' 6" the width and length would be 13' 6" and 21'. If this is too big, Mr. J. Moir suggests a ratio of 1 : 1.25 : 1.6 as a reasonable compromise, giving a room 8' 6" \times 10' 6" \times 13' 6". In this way, room resonances or eigentones are nicely staggered at about 70, 54 and 40 c/s, or, in the words of the dictator, you divide and conquer.

Due to standing wave effects, these resonances are not heard with equal intensity in all parts of the room. Even a strong 50 cycle hum may be inaudible at one point.

ELECTRICITY Most of the shocks we receive in audio affect our ears, but as the equipment is usually connected to the electricity mains and many people are rather hazy about the risk of electric shock, I posed a few questions to Mr. E. M. Price. (I picked on Mr. Price because I remembered watching him produce artificial lightning a few years ago at Bradford Technical College, now known as the Bradford Institute of Technology.)

The haziness to which I refer is illustrated by the actions of two retired friends of mine, who always pull out the mains plug on the TV set for safety before retiring at night, or during a thunderstorm, but when ironing the washing in the cellar the lady stands on the stone floor and does not use the wooden duck-board provided by the electrician, because it places her six inches too high.

According to our cartoonist, even the dealer may on occasion contribute to the confusion.



FIG. E/4.
Safety measures.

To go to the other extreme, say from haziness to absolute confidence, I was amazed last year when I watched an electrician making a new connection to the electric mains at our factory. He was standing in a hole in the road about 3 ft. deep, soldering away quite happily, handling live wires capable of delivering 100 to 400 amps at 240 volts, say up to 100 kw single phase; enough to electrocute a herd of elephants.* "How comes it," I enquired, "that you are still alive?" He explained that he was standing on a wooden board and did not expose more than one wire at a time, and was careful not to touch earth, otherwise he would soon be in heaven.

It is a long step from the lady with the electric iron, or the kettle, to our friend the electrician, but the following replies by Mr. Price may help to bridge the gap.

Q. *What is electricity?*

A. Particles of electricity, called electrons, form part of all matter. The co-ordinated motion of these electrons constitutes an electric current.

*Mr. Price says that talking about electrocuting elephants does not mean a thing in the technical or electrical sense, but I think it sounds most impressive.

Q. *How is electric current produced?*

A. The electricity in the form of electrons is always there. It can be pumped round the circuit either by a chemical pump—that is an electric battery—or by means of a mechanical pump, that is a generator or alternator.

Q. *What is earthing?*

A. Earthing is the connection to the mass of earth of the exposed metal parts of electrical apparatus.

Q. *What are the dangers of shock from radio and TV sets?*

A. Nearly all sets are built to conform to a British Standards Specification and are so constructed that ordinary-sized fingers cannot touch the metal parts without removing the back or one of the knobs.

Q. *Is there a danger from electric fires and similar equipment?*

A. Yes, unless they are so guarded that it is impossible to poke the finger, or a knife or fork, into the element. But frayed wiring or faulty earthing or switching may result in the actual frame of an electric fire becoming connected to the live side of the mains with dangerous results.

Q. *During a thunderstorm is there any point in disconnecting radio and TV sets from the mains and/or from the aerials?*

A. There is no point in disconnecting the set from the mains. There is some point in disconnecting the aerial, because a direct or induced stroke on the aerial could cause damage to the set, and injury to any person who happened to be handling the aerial lead or plug at the time.

Q. *What is a lethal shock in terms of voltage or current?*

A. One ampere will kill; one-thousandth of an ampere will not. How much current is passed through a shock victim depends upon the voltage and on the electrical resistance of the victim, which in turn depends to a considerable extent on the amount of moisture on or near the skin. One bar of an electric fire draws about 4 amps at 240 volts, which is more than ample to cook anybody's goose!

Q. *Is a bathroom shock far more dangerous?*

A. The bathroom is a very dangerous place electrically, partly because of the amount of earthed metal about—taps, bath, etc.—and partly because a person in a bathroom is often wet or moist and shows a low resistance to an electric current.

Q. *When using, for example, an electric iron is it a wise precaution to stand on a duck-board, particularly if you are in the cellar?*

A. In a carpeted or wooden-floored living room a duck-board is unnecessary. In the cellar I would advise my wife not to use an electric iron at all.

Q. *Is there any particular danger about portable electrical apparatus which is supposed to be earthed?*

A. Yes. The danger is that the earth wire, which is the safety wire, may break without the user being aware of it. The first

thing the user knows then is a severe shock. (This would only occur after prolonged use or abuse, or careless connection of the earth lead.)

- Q. *Does normal fuse protection prevent one from getting a lethal shock?*
 A. No. The fuse protects the wiring. Almost any fuse will pass twenty times as much current as is necessary to kill a person in any circumstances. E.M.P.

The dangers from electricity are there, but with reasonable care and modern equipment maintained in good condition there is nothing to worry about.

Mains Supply. For domestic equipment the colour code in Great Britain is:

Red = live or line
 Black = neutral
 Green = earth

Continental coding is different, and extra care should be taken when wiring up foreign equipment.



FIG. E/5.
Colour scheme.

"I THINK I'VE GOT IT NOW — THE RED WIRE TO THE RIGHT; THE BLACK TO THE LEFT AND THE GREEN ONE IS BURIED OUTSIDE IN THE EARTH!"

Switches are by regulation always fitted in the live line, but mistakes are sometimes made. When connection is made to a mains plug, reversing the wire to live and neutral pins would render the radio or TV switch ineffective in isolating the set from the live side of the mains.

It is wise to disconnect a TV set from the mains before removing the back; but all TV, radio and electrical installations and repairs are better left to the skilled service engineer or electrician.

Mains Test. To determine whether any metal or wire is "live" you can invest in a neon screwdriver, as illustrated in Fig. E/6.

There are two kinds: one is fitted with a 5 megohm resistor and works on either dc or ac, while the other depends on a capacitance effect and works only on ac. To make a test, hold the *handle only*

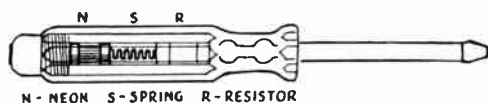

FIG. E/6.

Neon prod for detecting live side of mains or "live" metal in radio or TV set, or other electrical apparatus.

in the hand and touch the suspected wire or metal with the blade. If the neon glows the metal in contact with the blade is "live". The electric current which causes the glow passes through the handle and through your body but is far too small to have any effect on you—provided you do not touch the blade or live metal.

For an outlay of about 3s. 6d. you can make tests where necessary, including metal parts of radio and TV sets, to ensure that all switches are functioning correctly, and you have a handy little screwdriver into the bargain (also useful for checking spark production in motor cars).

When I submitted the neon screwdriver report to Mr. Price he replied as follows:

"I am bound to advise you that I think it is dangerous to recommend the neon screwdriver to the unskilled at all. The idea of thousands of innocent readers poking about their electrical installations with any form of screwdriver fills me with horror. The indications given by a neon screwdriver may be misleading to the not-so-skilled, and if there is any doubt about any installation one should consult an expert, or the local Electricity Board.
E.M.P."

So, you have been warned!

I must say that the idea of thousands of innocent people reading this book fills me with delight. I have had another look at my own neon screwdriver and I find it is well insulated down to $\frac{1}{4}$ " of the tip. It appears to be much safer than a broken 3-pin plug which, I confess, we use at home with an electric fire, one pin being fully exposed. A prod test proves it is not the "live" one. I wonder how much faulty equipment is in use throughout the country?

Talking of neon indicators, our technical editor recalls the interesting experience of Dobson and Young, who travelled many thousands of miles giving lectures on music to members of H.M. Forces both at home and abroad, during and after the Great War.

They naturally had to be prepared to operate their record-playing equipment from all kinds of electrical supplies. When Mr. Cooke asked Mr. Young in 1943 what sort of meter he used to check the voltage, Mr. Young, with the quiet smile of experience, produced a small neon lamp fitted with a holder and a short length of flex. "With this simple lamp," he said, "I can estimate mains voltage fairly accurately according to its brightness. Whether or not it flickers will indicate if the supply is ac or dc, and by inserting only one lead at a time I can establish which side is live."

This highly ingenious method of testing is commended to all itinerant gramophiles or much-travelled and bemused electric shaver addicts.

Finally, to placate Mr. Price, I am including a warning verse which appeared in the Third Edition of *Sound Reproduction*:

*Lord Finchley tried to mend the electric light,
It struck him dead, and serve him right.
It is the business of the wealthy man
To give employment to the artisan.*

Belloc.

ELECTROLYTIC CAPACITOR A type of capacitor or condenser which consists of aluminium electrodes immersed in an electrolyte.

The electrodes are covered with an extremely thin film of oxide which acts as the dielectric, the very high capacitance of this type of condenser being due to the thinness of the film.

The older type of wet capacitor containing electrolyte solution is now generally replaced by the dry type in which the electrolyte is in the form of a jelly.

Although electrolytic capacitors provide very large capacitance with small bulk, their losses are usually higher than metallised paper or Mansbridge types. This is due to leakage through the oxide film and the appreciable resistance of the electrolyte itself.

Normal electrolytic capacitors require a constantly applied polarising voltage to prevent the oxide film from deforming. Alternating voltages can be superimposed up to the limit set by the leakage resistance which is specified by the manufacturer.

They are employed chiefly in smoothing and decoupling circuits where the limitations mentioned are acceptable and the necessary working conditions can be applied.

In general, electrolytic capacitors should not be used in loud-speaker crossover networks, but recent developments in reversible types have shown interesting results and it may be possible to adopt these in the future, particularly for very low frequency networks at low impedance where high values of capacitance are required.

ELECTRO-MAGNET An arrangement for developing a magnetic field by passing current through a coil of wire wound on an iron core. Moving coil loudspeakers were normally mains energised in this way before the economic development of the permanent magnet. Other examples, still in common use, are electric bells and relays.

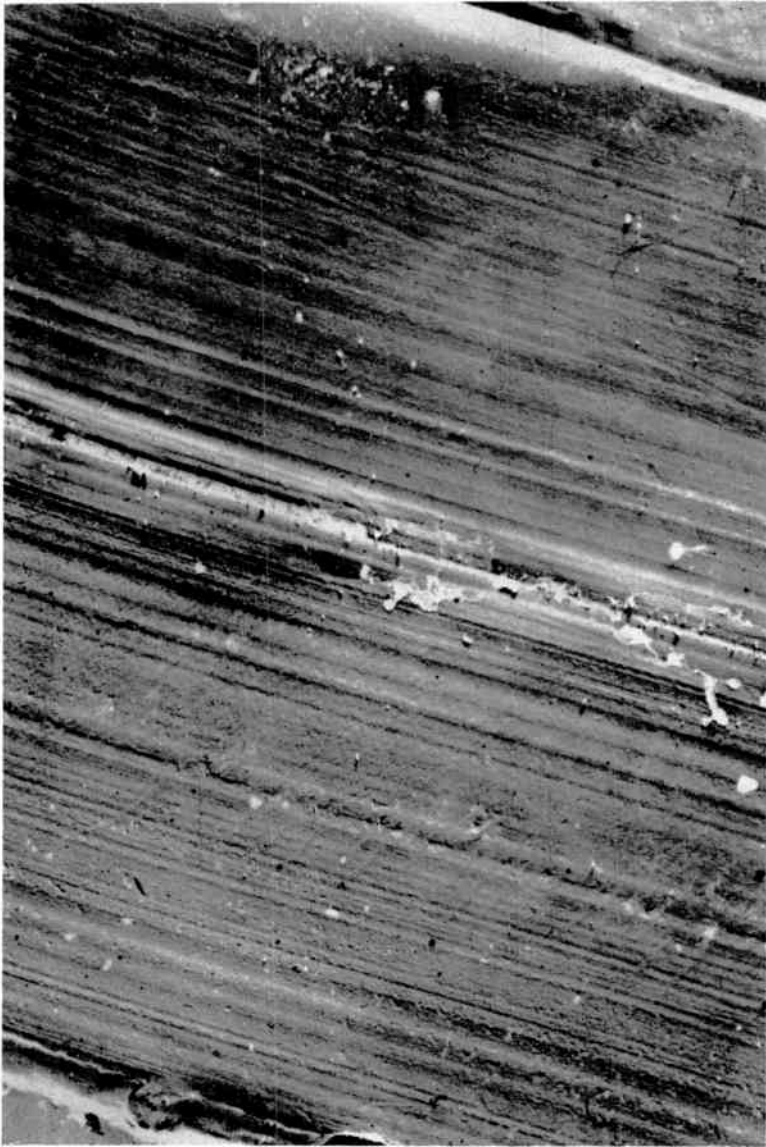

FIG. E/6A. *Part of unplayed microgroove as revealed by Electron Microscope.
Side view. Mag. 3,000x.*

ELECTRON MICROSCOPE This is a research tool which employs a beam of electrons in much the same way as the ordinary optical microscope uses light rays. Enormous magnifications are possible ranging from a minimum of 3,000 to over 60,000 times.

It is not possible to look directly at an object using the electron microscope; instead it is necessary to make a replica which is transparent to the electron beam.

Some preliminary work on the investigation of record grooves and styli has been done by Dr. P. Chippindale and Dr. P. Lord at Salford Royal Technical College. It is too early to say what the practical value of this avenue of research will be, but some idea of the astonishing detail revealed is seen in Fig. E/6A, which shows part of an unplayed, unmodulated microgroove. The small white specks are particles of sooty dust. (Page 74.)

As to Fig. E/6B, this is not an aerial photograph of Brighton beach; it is only the surface of a human hair.



FIG. E/6B. *Electron-microscopic view of human hair. Mag. 3,000x.*

A general view of the A.E.I. Electron Microscope is shown in Fig. E/6C, on page 75.

N.B. These electron micrographs and the photomicrographs R/16 and R/17 were taken by Dr. P. Chippindale, to whom we are greatly indebted.

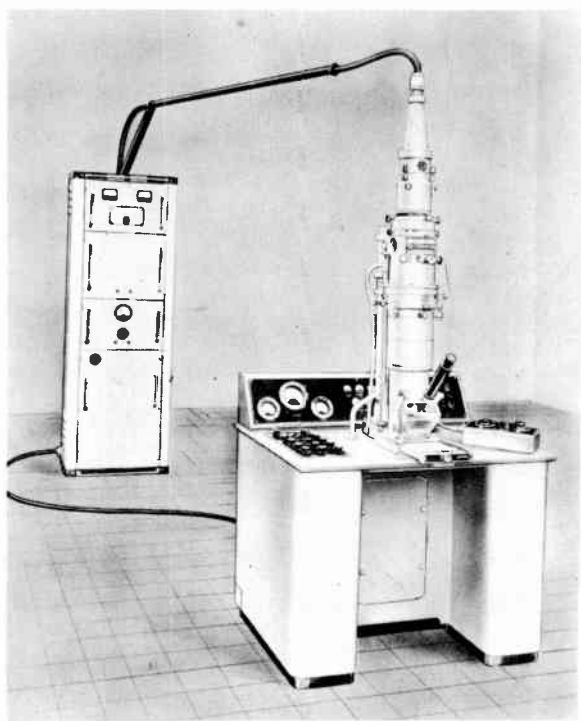

FIG. E/6c. *A.E.I. Electron Microscope.*

ELECTROSTATIC LOUDSPEAKER It is now about five years since P. J. Walker gave the first demonstration of a full range ESL at the Waldorf Hotel in London. This was, of course, a push-pull design, because single-sided types distort badly at frequencies below about 5 kc/s. Mr. Walker's demonstration caused quite a sensation and makers of permanent magnets began to wonder vaguely if their 25 years' monopoly of the loudspeaker "drive" market was to be undermined by modern plastic and electronic ingenuity. (It was an unusual sight to see sturdy Sheffield steel magnates trembling in their shoes.)

About the same time, push-pull electrostatic treble speakers had been developed in America and a model designed by Janszen gave a good account of itself, but was rather expensive to make.

The electrostatic loudspeaker uses the principle of a condenser. A schematic of the single-sided type is given in Fig. E/7.

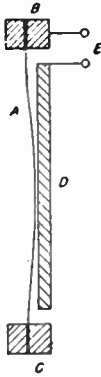

FIG. E/7.

Schematic of early electrostatic speaker.

A = Flexible diaphragm.

B and C = Clamped supports for A.

D = Perforated rigid backplate.

E = Input for ac signal and dc polarising volts.

Frequency range 7 to 20 kc/s.

Unfortunately, the sensitivity of this type of ESL is very low and it can only be used with middle and bass units of poor efficiency.

The push-pull design is quite a different kettle of fish and clean response down to 40 c/s is a practical proposition, given the necessary physical dimensions. Reasonable sensitivity is also obtained with polarising volts of about 1500 volts for treble and 4000 volts for the bass units.

The full range Quad ESL is still (June 1960) the only model commercially available in this country and enjoys a good reputation with those who like its unique properties.

In the fifth edition of *Loudspeakers* we gave a summary of the relative merits of the moving coil and electrostatic designs, and as I think that this evaluation is reflected by commercial experience to date, we are repeating the assessment here.

<i>Qualities Involved</i>	<i>Winner</i>
1. Low distortion	Electrostatic
2. Transient response	„
3. Directional effects	Equal
4. Portability and hardness	„
5. Frequency range attainable	„
6. Durability in temperate climates	„
7. Sensitivity	Moving coil
8. Wide choice of efficiency (in magnets)	„ „
9. LF power handling capacity	„ „
10. Robustness of working parts	„ „
11. Nuisance of polarising volts	„ „
12. Flexibility in design	„ „
13. Ease of production	„ „
14. Effect of extreme humidity	Not yet decided

The question of level response has been deliberately omitted because this is tied up with directional effects and problems of amplifier matching.

In weighing up the pros and cons we are, of course, considering speakers of similar size and cost.

Qualities 1 and 2 are very important and ensure a place for the ESL in certain applications, but qualities 7 to 13 cannot be overlooked for general application and should keep established loudspeaker makers out of the bankruptcy court for another year or two.

Sensitivity. This is to some extent bound up with frequency response, and it is possible to design electrostatic speakers having sensitivities equal to the best moving coils, if complexity and cost are ignored. Present models are, however, about 3-6 dB less sensitive than moving coil units with more than 10,000 oersteds flux density. It is generally necessary to attenuate the input to a high quality MC bass unit when it is used with an ESL tweeter.

The lower sensitivity of present ESL loudspeakers also requires a minimum amplifier power of 15 watts for full room volume without overloading, and this power requirement, plus the necessity of maintaining amplifier matching, makes it difficult, if not impossible, to run more than one speaker from a single amplifier. For similar reasons, the ESL cannot be used with success as a radio set extension speaker.

Distortion. One of the principal virtues of the electrostatic speaker is its very low harmonic distortion at normal operating levels. If, however, the LF input is increased beyond a certain point the onset of distortion is very rapid compared with the relatively smooth overload characteristic of moving coil loudspeakers.

On general programme, the bass of the ESL is adequate for all domestic requirements and the doublet type is at least free from boom.

EQUALISATION The principal use of equalisation in domestic equipment is in pickup and tape preamplifiers which correct for the recording characteristic.

Another application is in altering the response of amplifiers used with audio devices such as cutter heads, pickups, microphones and loudspeakers in which the response is not level with frequency.

EQUIVALENT CIRCUIT Electrical, mechanical and acoustic systems have much in common in spite of their dissimilarity. As an example, mechanical resonant systems such as automobile suspension devices may be damped by the addition of friction just as electrical oscillatory circuits are damped by the inclusion of resistance.

The behaviour of electrical circuits is generally easier to predict by inspection of a schematic diagram than that of mechanical systems. The mathematical treatment of complex electrical circuits is likewise very well documented.

For these reasons it is frequently desirable to represent mechanical or acoustic devices as electrical circuits or analogues so that their mode of behaviour may be studied. It is also possible to carry out practical experiments using equivalent circuits and afterwards reconvert the result into mechanical or acoustic elements.

This subject of electrical analogues is rather complex and interested readers are referred to *Dynamical Analogies* by H. F. Olson, and *Acoustics* by L. L. Beranek.

A simplified table of equivalents is given below:

TABLE OF ELECTRICAL, MECHANICAL
AND ACOUSTIC EQUIVALENTS

<i>Electrical</i>	<i>Mechanical Rectilinear</i>	<i>Mechanical Rotational</i>	<i>Acoustic</i>
Resistance	Friction	Rotational Friction	Acoustic Resistance
Inductance	Mass	Moment of inertia	Inertance
Capacitance	Compliance	Rotational Compliance	Acoustic Compliance
EMF	Force	Torque	Pressure
Current	Velocity	Angular Velocity	Volume Current
Charge	Displacement	Angular Displacement	Volume Displacement

ERASURE In the majority of domestic tape recorders the tape is erased before passing to the recording head. This is accomplished by subjecting the tape to a strong magnetic field which is alternating at supersonic frequency. As the tape approaches the erase head the field builds up to a maximum and diminishes steadily as it moves away.

When high coercivity tapes are used with older types of recorder, the erase current may not be large enough to erase the previous recording completely, especially if the earlier recording has been overmodulated. In such cases it is advisable to run the tape through the machine once or twice beforehand with the controls set to "record" and the input gain control at zero. This will usually result in a cleaner tape. A quicker method is to use a bulk eraser, referred to under Demagnetisation.

Supersonic erasure is sometimes dispensed with in portable or inexpensive equipment. Instead, the tape is moved past a small permanent magnet. This method certainly erases the previous programme but unfortunately leaves the magnetic particles in a

semi-magnetised condition and produces recordings having high background noise. A bulk eraser is the answer.

Accidental Erasure. It goes without saying that tape recordings may be erased accidentally by stray fields from transformers, electric motors and permanent magnets. At worst the recording may be rendered completely useless whereas in less severe cases an audible swish or high background noise may result.

ERG The unit of work in the cgs system. Ten million ergs equal one Joule.

EXPONENTIAL HORN This is a shape in which the cross-sectional area is doubled as the length of the horn is doubled; in other words the flare increases at a logarithmic rate.

One of the earliest applications of this principle to sound reproduction was probably the re-entrant gramophone produced by HMV in 1927 and illustrated in Fig. E/8.

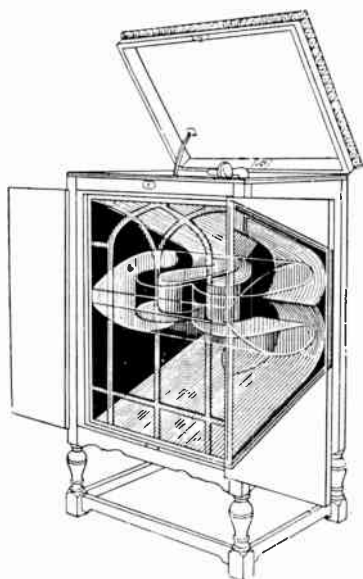

FIG. E/8.

*Re-entrant exponential gramophone,
dating back to 1927.*

Courtesy E.M.I. Ltd.

The object of horn loading is to match the acoustic impedance of the loudspeaker diaphragm to the surrounding air, thus giving a better transfer of energy.

An infinite variety of shapes is possible between conical and hyperbolic, the exponential flare coming about half-way between the two, as shown in Fig. E/9.

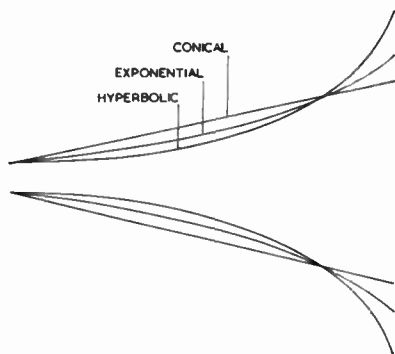

FIG. E/9.
Various horn shapes.

There are several factors which govern the performance of horn loading and limit its effectiveness to about three octaves. In addition to rate of flare, the shape (straight or folded), throat size and shape, mouth size and shape, overall length of horn, all play their part. Merely to be exponential or hyperbolic is not enough. To be conical is dreadful.

F

F.C.C. Federal Communications Commission (U.S.A.),
New Post Office Building, Washington, 25, D.C.

Deals with licensing, standards, frequency allocations, etc., within U.S.A. on a national basis and represents U.S. communications interests at International level.

FM Frequency modulation; often referred to in radio transmissions as VHF or very high frequency.

In contrast to AM, the power output from an FM transmitter does not change, but the frequency of the carrier varies, the magnitude and rate of deviation being in sympathy with the information to be transmitted, as illustrated in Fig. F/1.

FAHRENHEIT Named after its German inventor (1686-1736) this thermometer gives the freezing point of water as 32° and boiling point at 212° . To convert degrees fahrenheit to centigrade, subtract 32, multiply by 5 and divide by 9.

FIG. F/1.

*Carrier wave modulated by LF signal.
Modulation varies according to
amplitude and frequency of signal. (See
Deviation.)*

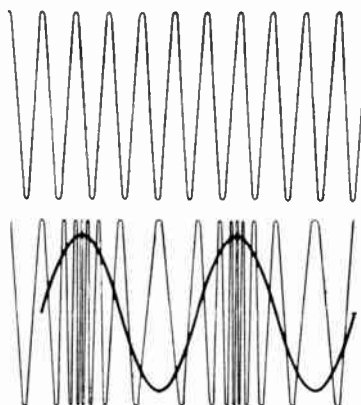

FARAD Named after the English scientist Michael Faraday (1791–1867) the farad is the unit of capacitance.

When 1 volt is applied across a capacitance of 1 farad a charge of 1 coulomb is stored. As the farad is too large for practical work it is usually subdivided as follows:

microfarad = μF or Mfd = 1 millionth.
nanofarad = nF = 1 thousandth of a millionth.
picofarad = pF = 1 millionth of a millionth.

FILTER A device which transmits electrical, mechanical or acoustic energy in varying amounts dependent on frequency.

There are scores of filter designs used in audio, the most common being smoothing circuits and tone controls in amplifiers, dividing networks in loudspeaker systems, anti-vibration mountings with pickups and turntables, and band-pass circuits in radio sets.

FLETCHER & MUNSON The apparent loudness of a sound depends upon frequency as well as intensity.

In 1933, H. Fletcher and W. A. Munson of the Bell Telephone Laboratories, U.S.A., published the results of their important investigation into the physiological aspects of loudness, including the now famous equal loudness contours illustrated in Fig. F/2, without which no book on audio is complete.

*When Fletcher said to Munson,
"That noise gets on my nerves;
And yet the nuisance varies
As pitch or volume swerves."
Munson replied, "Let's find out why!"
Hence Fletcher-Munson curves.*

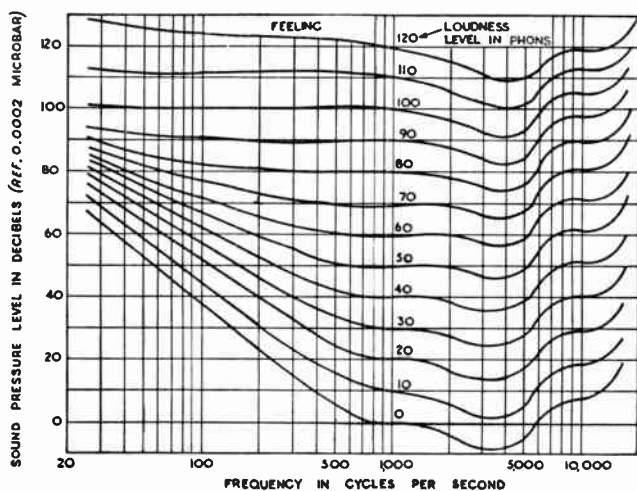

FIG. F/2. *Equal loudness contours for pure tones.*
After Fletcher and Munson.

FLUTTER A waver in the reproduction of sound caused by spurious variations of speed in either recording or reproduction, usually occurring at 10 c/s or more. Slower speed variations are known as wow, and the once-around variety at $33\frac{1}{2}$ rpm would affect pitch every 1.8 second, the frequency being 0.55 c/s. At 78 rpm the wow would occur every 0.77 sec or at 1.3 c/s.

Flutter and wow are actually a form of frequency modulation, and the effect of a strong 20 c/s flutter, say 12%, on a pure tone at 100 c/s is depicted in Fig. F/3.

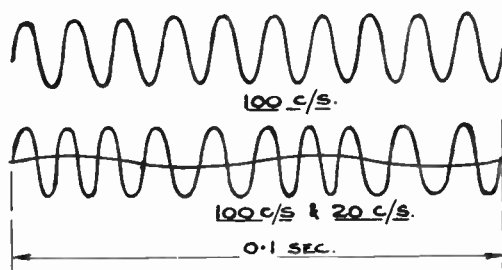

FIG. F/3.

Effect of 20 cycle flutter on 100 c/s pure tone.

In high-class equipment the peak to peak wow or flutter should not exceed 0.4%. Lack of precision in record players and tape recorders is mainly responsible for the trouble, although a warped disc or one with hole off-centre will produce wow.

The ear is most sensitive to flutter in the treble, the best test being a steady tone at 3 kc/s from a frequency test record or tape. The next best would be an oboe solo.

FLUX DENSITY The field strength of a magnet in lines per sq.cm. The word gauss has also been used here, but the correct expression is oersteds.

The flux density of loudspeaker magnets is the quality that costs the money and is just as important as horse power in a motor car. (The only audio engineers who ignore this fact are those who never have to pay for magnets!) Loudspeaker magnets range from about 5,000 oersteds to over 20,000, but the diameter of the gap must also be considered because the total flux (maxwells) gives the true indication of value. For example, 13,000 oersteds with a centre pole 1" dia. and $\frac{3}{16}$ " gap depth gives 54,000 maxwells at a cost of about 30s. But 13,000 lines with a 2" centre pole gives 170,000 maxwells and costs about 95s. for the complete magnet with same gap depth.

High flux density improves transient response and has the following effect on output:

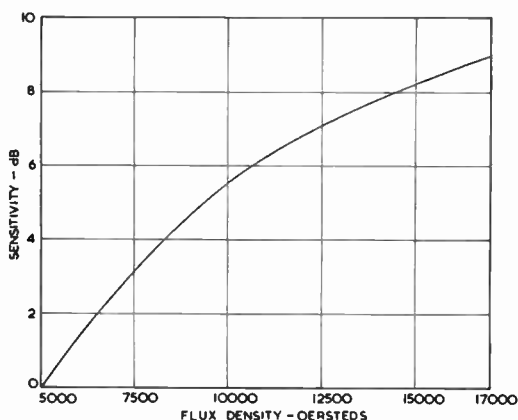

FIG. F/4.

Speaker output related to flux density with white noise input.

FOAM PLASTIC Expanded flexible foams of polyether or polyester materials, produced in a variety of textures and densities.

Qualities of softness and resilience make these materials very suitable for cone surrounds in loudspeakers as well as for damping purposes in other small mechanisms.

The range of available colours is limited and as the basic material changes colour in the course of time, this affects the colour of the finished product but does not upset the performance of a loudspeaker.

FORMANT TONES Although the formant tones are the qualities that enable us to recognise voices, musical instruments and even articulation in speech, we hear very little about them, and most books on the subject of sound reproduction ignore them altogether.

A good illustration is to be found in *Wave Motion and Sound*, where the formant tones associated with vowel sounds and a final consonant *t* come out as in Fig. F/4A.

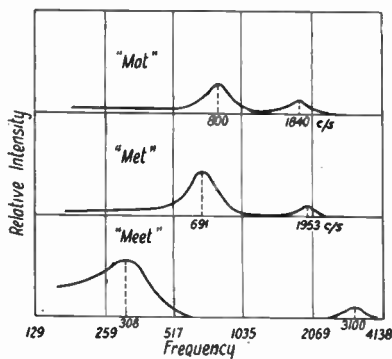

FIG. F/4A.

Formant tones associated with the production of the words mat, met, and meet.

From *Wave Motion and Sound* by Stephens and Bate.

The generating system of the human voice is likened by Stephens & Bate to two Helmholtz resonators (similar to a trombone) in which the larynx (with its vocal chords) forms one resonator, the cavities of the throat, mouth and nose forming the other, joined by the glottis.

The interesting point is that all these human resonators are different, enabling us to recognise voices, and yet the formant tones are sufficiently alike to enable us to understand speech.

Each musical instrument has its own group of formant tones, and if these coincide with a resonance in a reproducer the results are unpleasant. The perfect loudspeaker must have no formant tones of its own; in short, it must be a reproducer of speech and music but *not* a producer.

The difference between harmonics and formant tones is that harmonics occur at or near specific frequencies which are multiples of the fundamental, whereas the formant tones are grouped together over a range of about half an octave.

FREE FIELD A sound field free from reflecting surfaces. The only perfect free field is the open air with the loudspeaker and microphone so placed that they are clear of reflections from ground or buildings. The B.B.C. at their research station at Kingswood Warren think nothing of hoisting such

devices 55 ft. above the ground in order to make accurate measurements, but it is generally agreed that B.B.C. engineers have lofty ideals.

Free-field conditions can be simulated in anechoic or dead rooms (briefly described under Anechoic), in which ground or floor reflections are avoided by grids as shown in Fig. F/5, with absorbent wedges underneath.

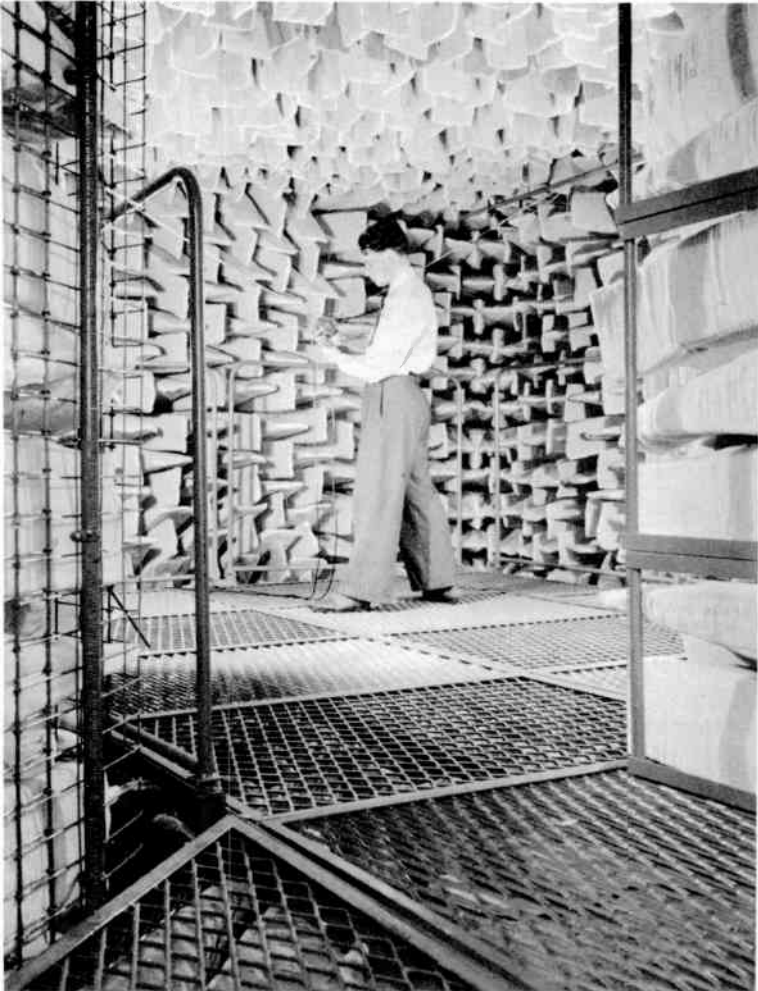

FIG. F/5. *G.P.O. dead room.*

Courtesy H.M.
Postmaster General.

A room 15 ft. long after treatment gives near-perfect free-field conditions down to 150 c/s, but useful measurements can be made at much lower frequencies.

In view of the fact that response curves are not the final criterion on which loudspeakers should be judged, their main value is for purposes of comparison during design and development work. Quick and useful tests can therefore be made under controlled conditions with the minimum of reflections.

We have found the absorbent enclosure of Fig. F/6 (after a design by D. E. L. Shorter) most useful in this connection. Double layers of absorbent material are fixed on all six sides, with extra oblique layers above the floor.

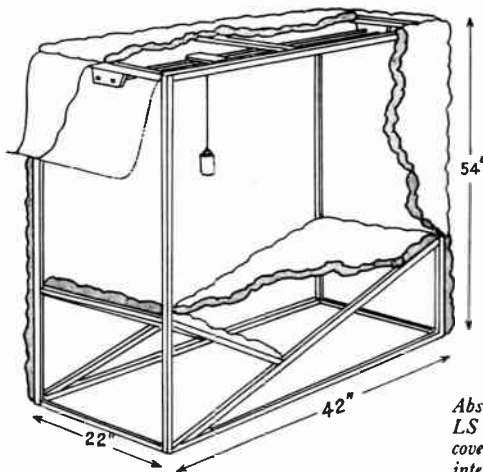

FIG. F/6.

Absorbent enclosure used for measuring LS response in live rooms. (Absorbent covers partly removed to expose interior.)

FREQUENCY Rate of recurrence of vibration. In sound waves, the number of repetitions per second. The frequency range is often divided into three groups, high, medium and low, abbreviated HF, MF and LF. There is no law governing this division, but an average application would be:

	<i>Frequency Range</i>	<i>Approx. Wavelength</i>
HF	2,000 to 20,000 c/s	6 in. to 0.6 in.
MF	100 to 2,000 c/s	11 ft. to 6 in.
LF	20 to 100 c/s	56 ft. to 11 ft.

In music, the most interesting aspect of frequencies is that we use the tempered scale, which means that a quarter of a semitone has to be split up evenly between the twelve notes of each octave. When tuning a piano, the fifths upwards are slightly flatter than perfect fifths, major thirds are sharpened, and so on, calling for

great skill from the tuner.

Calculating to the nearest decimal up to 1,000 c/s and to the nearest frequency above this point (a standard of accuracy much keener than the average ear), the notes of the tempered scale emerge with the following vibrations per second:

FREQUENCIES OF
EQUALLY TEMPERED SCALE A=440 c/s

	C ₄ -C ₁₆	C ₁₆ -C ₂₈	C ₂₈ -C ₄₀	C ₄₀ -C ₅₂	C ₅₂ -C ₆₄	C ₆₄ -C ₇₆	C ₇₆ -C ₈₈
C	32.7	65.4	130.8	261.6	523.2	1046.0	2093.0
C#	34.6	69.3	138.6	277.1	554.2	1108.0	2217.0
D	36.7	73.4	146.8	293.6	587.2	1174.0	2348.0
D#	38.9	77.8	155.6	311.1	622.2	1244.0	2488.0
E	41.2	82.4	164.8	329.6	659.2	1318.0	2636.0
F	43.6	87.3	174.6	349.2	698.4	1397.0	2794.0
F#	46.2	92.5	185.0	369.9	739.8	1480.0	2960.0
G	49.0	98.0	196.0	391.9	783.8	1568.0	3136.0
G#	51.9	103.8	207.6	415.3	830.6	1661.0	3322.0
A	55.0	110.0	220.0	440.0	880.0	1760.0	3520.0
A#	58.3	116.5	233.1	466.2	932.3	1865.0	3730.0
B	61.7	123.4	246.9	493.8	987.7	1975.0	3950.0
C	65.4	130.8	261.6	523.2	1046.4	2093.0	4186.0

Bottom C = C 4

Middle C = C 40

Top C = C 88

Bottom A = A1 and is 27.5 c/s.

Bottom B = B3 and is 30.8 c/s.

FREQUENCY—CUT-OFF This is the frequency above or below which audio equipment ceases to function with full efficiency. The point at which response is 3 dB down and then continues to fall would usually be cited as the cut-off frequency; a sudden stop is rarely experienced or expected.

With an open baffle, clear of floor or wall, response falls off at 6 dB per octave at frequencies below a point determined by its size. (See Piano chart.)

With an exponential horn, the mouth must be a quarter wavelength, say 4 ft. dia. to go down to 60 c/s, and the rate of flare must double in not less than 12". Doubling the rate of flare raises the cut-off frequency by an octave.

FREQUENCY DOUBLING This usually occurs in a loudspeaker at frequencies below the main cone resonance, but it depends also on linearity of suspension, power input and method of mounting.

When it occurs, notes one or two octaves above the input frequency are produced and a pure tone may be converted into a rattle. Testing at a very low frequency, say 20 c/s, the speaker which makes the most noise is always the worst.

Distortion from doubling can of course be avoided by using very low input level, with very little cone movement. A moving coil microphone with input of a few milliwatts may be quite linear in cone movement, but used as a loudspeaker and fed with a full watt

from an amplifier it would double frequencies over a wide range and probably double up completely in a short time.

The following oscillogram shows at A the output from an 8" unit with a resonance at 70 c/s and doubling getting worse as the frequency goes down, until there is little or no fundamental left. Then at B, *mirabile dictu*, a better magnet damps out the cone resonance, reduces cone excursion and virtually eliminates doubling.

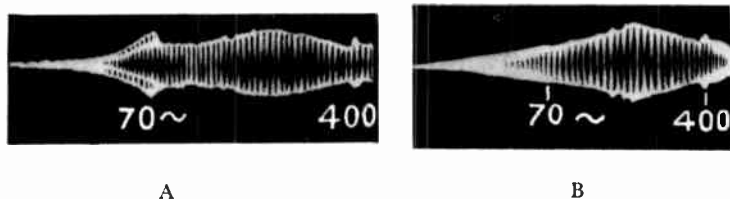

FIG. F/7. Oscillograms of free-field response from same cone and coil assembly.
 Input 1 watt. 8" unit.
 A With 8,000 oersted magnet.
 B With 13,000 oersted magnet.

Harmonic Analysis. The degree of frequency doubling can be measured by harmonic analysis. Second, third and fourth harmonics may be produced at various intensities.

The following test, made eight years ago, shows the effect of conditions of mounting and is still valid, although 2 cu.ft. enclosures fitted with suitable 12" units can be designed today to go down to 30 c/s without distortion at reasonable output levels.

The large enclosure of Fig. F/8 not only eliminates the 120 c/s hump, but also reduces the peak at 80 c/s.

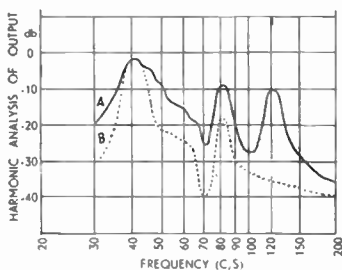

FIG. F/8.

Frequency doubling with 8" unit at 40 c/s. Input $\frac{1}{2}$ watt.
 A In 2 cu.ft. reflex enclosure.
 B Same unit in 9 cu.ft. corner reflex enclosure.

It is naturally easier to produce good bass from large speakers and enclosures than from small ones. 'Twas ever thus and always will be. The next test, also eight years old, shows a perfect 40 cycle note with 15" unit, and a slight third harmonic with input at 30 c/s (which could easily be avoided today).

FIG. F/9.

15" unit in 9 cu.-ft. corner enclosure.

Input $\frac{1}{2}$ watt.

A—30 c/s.

B—40 c/s for comparison with
Fig. 8.

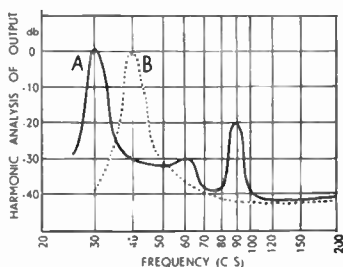

On a listening test, harmonic peaks which are 20 dB less than the fundamental are difficult to detect. A speaker system which is free from frequency doubling above about 40 c/s sounds smooth and warm in the bass and often quieter than a less linear set up.

FREQUENCY RANGE The following table gives the range covered by instruments and voices. Harmonics go very much higher, depending on the instrument and how loudly and sometimes how badly it is played.

<i>Instrument</i>	<i>Frequency range of fundamentals</i>
Pipe Organ	16—8,000 c/s
Piano	27.5—4,000 c/s
Harp	30—2,500 c/s
Double Bassoon	33—350 c/s
Double Bass	41—380 c/s
Bass Tuba	42—380 c/s
Timpani	45 c/s
Bassoon	60—700 c/s
French Horn	70—600 c/s
Cello	70—350 c/s
Bass Clarinet	75—700 c/s
Guitar	82—700 c/s
Trombone	85—500 c/s
Snare Drum	80 c/s
Kettle Drum	96 c/s
Banjo	110—800 c/s
Viola	150—1,500 c/s
Clarinet	150—1,700 c/s
Trumpet	190—980 c/s
Violin	196—3,200 c/s
Oboe	210—1,700 c/s
Flute	300—2,500 c/s
Cymbals	probably 350—16,000 c/s
Piccolo	450—3,800 c/s
Triangle	500—16,000 c/s
<i>Human Voice</i>	
Bass	90—300 c/s
Baritone	110—400 c/s
Tenor	150—500 c/s
Alto	190—700 c/s
Soprano	280—1,050 c/s

Hand clapping includes random frequencies over a wide range, probably from 100 to 15,000 c/s.

It will be seen from Fig. F/9A that the B.B.C. cover a range of 40 to 15,000 c/s within 5 dB, and this is normally transmitted on VHF programmes. It is admitted that on medium and long wave transmissions the response falls off above 10 kc/s much more steeply.

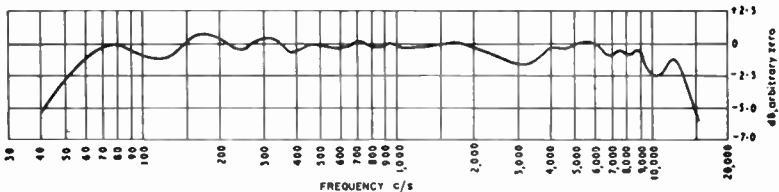

From B.B.C. Engineering Division Monograph, March 1958. No. 16.

FIG. F/9A. Overall frequency response of microphone, amplifier and programme meter for sound source on microphone axis.

It would be fair to say that disc recording covers a similar range to VHF.

The response curve of the $7\frac{1}{2}$ " /sec portable tape recorder used in these B.B.C. tests (developing a peak programme meter) is reproduced in Fig. F/9B.

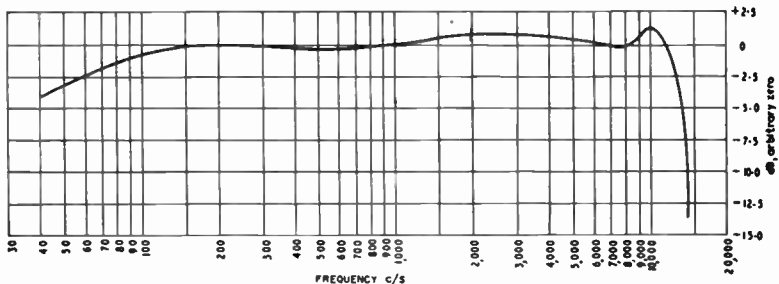

From B.B.C. Engineering Division Monograph, March 1958. No. 16.

FIG. F/9B. Frequency response of tape recorder used in tests by Mr. Shorter and Mr. Manson.

On the other hand, a professional tape recorder at 15"/sec would go half an octave higher than the curve shown in Fig. F/9B.

FREQUENCY RESPONSE Modern audio equipment can be made to give an adequate frequency response without much difficulty, although there is still a marked difference between the self-contained, mass produced, packaged product and the specialised assembly. (Fortunately—for the hi-fi industry.)

The introduction of electrical recording in 1924 and the moving coil speaker a few years later were the great landmarks in widening the available range, as the following typical response curves clearly show.

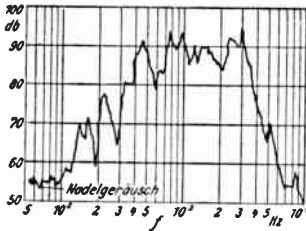

FIG. F/10.

Response of mechanical soundbox.
From Elektroakustisches Taschenbuch,
G. Neumann & Co., Berlin.

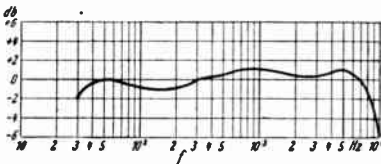

FIG. F/11.

Response of early electric pickup system.

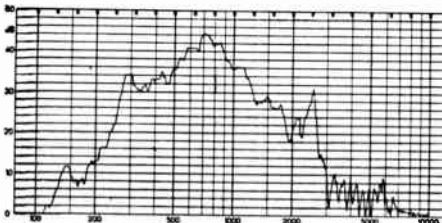

FIG. F/12.

Response curve of early horn loaded speaker with earphone type of driving unit.

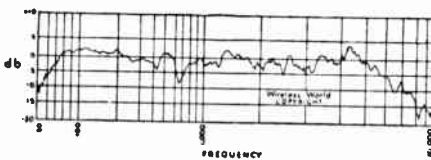

FIG. F/13.

Response curve of 10" speaker taken by Wireless World in 1936.

FRINGE AREA The signal strength of a radio or TV transmitter gradually diminishes with increasing distance from the station due to absorption and scattering of the radio waves. The fringe area is the region in which the signal strength available from a good aerial is considered to be weak for satisfactory operation with standard receiving equipment. Better results may often be obtained using very directional aerials and special booster amplifiers to "pull in" a stronger signal to the receiver. (See VHF and TV headings for the latest B.B.C. maps showing areas already covered and new transmitters planned for 1960 and 1961.)

FUNDAMENTAL In music this is the lowest note of a chord and also the lowest frequency in a single note, with harmonics which provide the tone quality.

In transducers, the fundamental resonance is the frequency region in which the mass of the vibrating system resonates naturally.

In a full range loudspeaker, this resonance must be at a low frequency because there is a loss of output below it, plus the risk of frequency doubling. The success of the small cabinet speakers (up to 2 cu.ft.) has been due to the fundamental fact that the fundamental resonance of such systems has been brought down about an octave during the last few years.

FUSE A protective device designed to interrupt the supply of current to electrical equipment in the event of serious overloading.

Ordinary fuses used in audio equipment consist of a short length of fine tinned copper wire encased in a glass tube fitted with metal end caps. Such fuses will blow within 10 milliseconds when passing five to ten times their rated current.

As fuses are designed to blow as a result of excessive current, the voltage rating is not very important and a 250 volt fuse can be used in a lower voltage circuit if the current rating is correct. But a low volt fuse should not be used in a circuit of much higher voltage because arc-over may result in the holder.

If a loudspeaker is connected to an amplifier capable of supplying power greatly in excess of the speaker's rated capacity—say a 50 watt amplifier driving a 10/15 watt speaker system—fuse protection from accidental overloading is worth consideration.

The standard type of $1\frac{1}{4}$ " "slow blow" cartridge fuse can be used in series with the speaker. A 250 mA type will protect a 10/16 ohm unit above 15 watts, but the fuse value should be increased to 500 mA with 8/10 ohm speaker systems, or 750 mA with 2/5 ohm types.

G

GAIN Another term for amplification. An amplifier which delivers an output of 10 volts for an input of 1 volt is said to have a gain of 10. (For tax purposes we should say 9!)

GAUSS The unit of magnetic induction in the cgs system, named after the German mathematician and astronomer Karl Friedrich Gauss 1777-1855.

One gauss equals one maxwell per sq.cm.

GILBERT The unit of magnetomotive force in the cgs system, named after the English physicist William Gilbert 1540-1603. One gilbert equals 0.796 ampere turn.

GRAMOPHONE The modern version is either a radiogram (probably stereogram) or a record player. Many radiograms include AM and FM receivers, with automatic record changers, although some are now fitted with transcription turntables. The cabinet work is usually first class with attractive appearance, and prices may range as high as £400.

Even so, we are inclined to agree with the Editor of *Hi-Fi News* when he writes (April 1960) as follows:

"We have always maintained that any, and as many units as maybe, can be housed satisfactorily in one box, *provided that the pickup and the speaker do not share the same box. We have also maintained that record-changers have no place in true high-fidelity.* We repeat this now."

GREEK ALPHABET Greek letters are widely used as symbols in electrical technology. We are therefore reproducing the full alphabet for reference purposes.

Letter.		Name.	English Equivalent.
Small.	Capital.		
α	Α	Alpha	A
β	Β	Beta	B
γ	Γ	Gamma	G
δ	Δ	Delta	D
ε	Ε	Epsilon	E
ζ	Ζ	Zeta	Z
η	Η	Eta	E
θ	Θ	Theta	Th
ι	Ι	Iota	I
κ	Κ	Kappa	K
λ	Λ	Lambda	L
μ	Μ	Mu	M
ν	Ν	Nu	N
ξ	Ξ	Ksi	—
ο	Ο	Omicron	O
π	Π	Pi	P
ρ	Ρ	Rho	R
σ	Σ	Sigma	S
τ	Τ	Tau	T
υ	Υ	Upsilon	U
φ	Φ	Phi	Ph
χ	Χ	Chi	Ch
ψ	Ψ	Psi	—
ω	Ω	̄Omega	O

GROOVE GUARD A method of construction used with modern 12" records in which the engraved portion is slightly thinner than the central area and the periphery, to prevent the recorded grooves of adjacent records from coming into contact when discs are placed together or piled up on automatic changers.

A press used for shaping the metal master to provide the groove guard is illustrated in Fig. G/1. The dies here are the exact counterpart of those used in the final record press.



Courtesy Decca

FIG. G/1. Machine for providing raised portions in 12" LP records.

For groove protection in 7" records, the centre portion only is raised.

GROUND An American term for earth.

H

HF High frequency. There is no law here, but anything above 2,000 c/s (one octave below top C on the piano) might reasonably be included in the HF range.

HT High tension; a term used to denote voltages in the range 60–1,000 v approximately.

HAAS EFFECT It was shown by Haas that, due to precedence, when two or more loudspeakers are in use, the listener only appears to hear the one nearest to him, provided the volume levels are similar.

The same sort of thing happens at a crowded cocktail party, where the only person whose voice you can hear clearly is the one standing close to and facing you (unless you stay too long, when even he may become blurred and indistinct).

Echo. Haas also proved that a separate echo is not heard until the time delay reaches 50 milliseconds, equal to a path difference of 56 ft., and that echo has negligible disturbing effect on the listener if it is 10 dB lower in level than the original.

Recording. The Haas effect is also used in certain multiplex stereo systems, such as the EMI–Percival system, in which locational information is provided by the starting transients.

Listening. In spite of the Haas effect, which benefits solo items, the difference to reproduction and room resonance brought about by using an extra loudspeaker can be quite impressive. If a listener is placed at an equal distance from the two speakers, the sound appears to come from a point half-way between them, again useful for natural effects on solos.

HANGOVER A perfect loudspeaker would cease to vibrate immediately any applied signal is cut off. Failure to do so is mainly due to resonance, and the unwanted output is sometimes referred to by the unpleasant word hangover. Its effect is to colour the reproduction and spoil the transient response. The worst offender is often the cabinet.

HARMONIC A musical sound contains a number of harmonics or overtones which are multiples of the fundamental frequency. A noise contains random frequencies and therefore sounds less pleasant to the ear.

The harmonic contents of a note provide its tone colour. Low notes are much richer than high ones and often give greater satisfaction to the ear for this reason. A test on a grand piano shows as many as 16 harmonics in note C 65.4 c/s, with only 4 harmonics in A 440 c/s. These are illustrated in Fig. H/1.

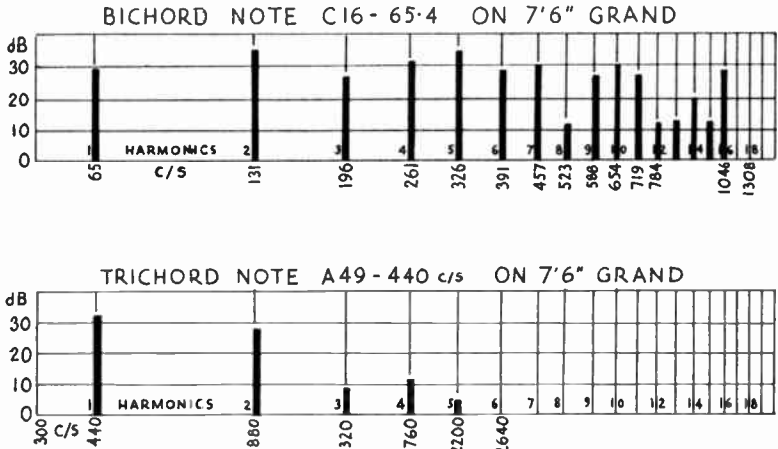

From *Pianos, Pianists and Sonics*

FIG. H/1. Harmonic analysis of two piano notes, showing high rate of overtones in bass compared with treble.

The following oscillograms show the same sort of difference in a more pictorial way.

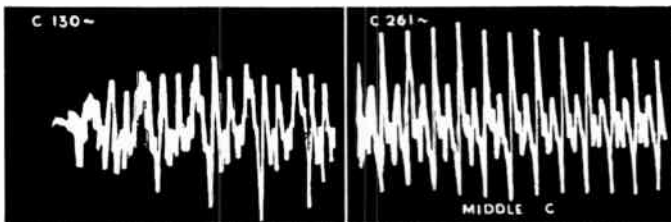

FIG. H/2. Oscillogram showing difference in harmonics between two piano notes only one octave apart.

The harmonics of musical sounds also vary with loudness, as shown in Fig. H,3.

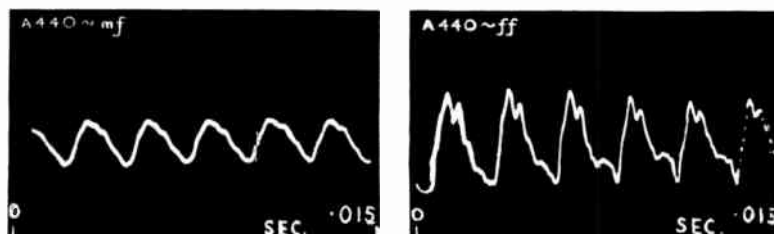

FIG. H/3. Oscillogram showing increase in harmonics when piano note is played loudly.

HARMONIC DISTORTION The introduction of any harmonics into reproduced sound which were not present in the original constitutes harmonic distortion.

Frequency doubling in loudspeakers is one form of the disease, but it has most commonly been associated with amplifiers, particularly when a single pentode brought out odd harmonics and gave a "wiry" type of reproduction. Any non-linearity in recording and reproducing equipment will result in harmonic distortion, with intermodulation products.

Modern amplifiers can be produced with harmonic distortion as low as 0.1% over the entire frequency range at full output levels, which represents perfection so far as the ear is concerned.

There are several ways of measuring harmonic distortion and these are fully described in the large *Audio Cyclopaedia* by H. M. Tremaine, published by Howard W. Sams, N.Y., and costing £6 6s. in Gt. Britain.

HEADPHONE See Earphone.

HEARING AIDS All hearing aids are now transistorised with the exception of a large number of the free *Medresco* types supplied under the National Health Service. About half a million of these valve types (weighing nearly 1 lb. each) are in use, but the transistor model (weighing 2½ oz.) is now being issued on a priority basis at the rate of 10,000 a month.

No less than 36 commercial models, all with transistors, are available. Some 20 are body-worn, a dozen are at ear level, and four fit in the ear, efficiency falling off as size is reduced. The frequency range normally covered is about 200 to 4,000 c/s.

HENRY The practical unit of inductance named after the American scientist Joseph Henry, 1797-1878. An inductance of one henry will store ½ joule of electrical energy when a current of one ampere is flowing.

The henry is usually subdivided as follows:

1 millihenry (mH)=one thousandth of a henry

1 microhenry (μ H)=one millionth of a henry

HERTZ A term used on the continent for cycles per second, and so named after the German physicist Heinrich Hertz, 1857-1894.

HI-FI An abbreviation of High Fidelity, Hi-Fi is a term which has today lost any real significance as a result of misuse, first on equipment with exaggerated "top" and bass, and later to describe cheap, mass-produced outfits with "mellow top" and no real bass at all.

The true meaning of the expression is natural reproduction and there is a lot of evidence that more and more listeners are now taking this as their main objective.

HIGH PASS FILTER A frequency or tone control circuit which discriminates against low frequencies.

HILL AND DALE Otherwise known as vertical recording, as distinct from lateral recording normally used.

The original Edison phonograph used the hill and dale method of indenting the sound waves on a cylinder. Many very good stereo records were made experimentally a year or two ago, combining lateral and vertical recording (in this country notably by A. R. Sugden), but the system was discarded commercially in favour of the 45/45 technique.

HORN LOADING The object of horn loading is to match the acoustic impedance of the loudspeaker diaphragm to the surrounding air, thus obtaining a maximum transfer of energy. It is still the most efficient form of LS mounting, and this is borne out by the fact that cinema speakers will cover an audience of 1,000 with one 25 watt amplifier working with less than 2% distortion in output.

The first loudspeaker must have been a telephone receiver fitted with a conical horn more than forty years ago. Since then, many elaborate designs of front and back loading horns have been evolved, notably by Voigt in this country and Klipsch in America.

As usual with loudspeakers, nature is perverse, and you need a short, narrow horn for good HF performance, but a long, big-mouthed fellow for good LF output. It is, in fact, difficult to cover more than three octaves adequately in one flare, and this limitation has operated against more widespread use of horn loading for domestic listening.

As to results, some people like horn loading and some don't.

The subject is too vast to be covered in a book of this nature. (See Exponential.)

HUM The main causes of hum are as follows:

1. Inadequate shielding of low level high impedance circuits and associated wiring.
2. Inadequate smoothing in HT supply.
3. AC supply to valve heaters in preamplifier stages.
4. Low level input wiring, such as pickup and microphone lines, unbalanced with respect to earth.
5. Magnetic coupling between mains transformers or smoothing chokes and tape recorder heads or pickups.

Some hints on prevention and cure now follow:

1. All such wiring should be in screened flex, the inner conductor being surrounded by a closely woven covering of tinned copper braid, earthed at one point only to avoid earth loops. An outer covering of PVC is advisable to prevent accidental contact with earthed metal parts.
2. With good equipment, HT smoothing is adequate, but if hum suddenly develops it may be due to failure of a smoothing capacitor.
3. Hum is often introduced via valve heaters. An ac supply to preamplifier valves can be balanced about earth by using a centre-tapped transformer, or better still with a potentiometer which can be adjusted for optimum results.
4. Long leads to pickups, tape heads and microphones should be twisted and balanced about earth as shown in Fig. H/4.

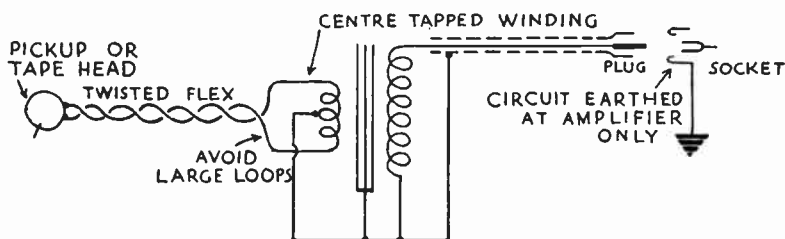

FIG. H/4. Input circuit with centre-tapped transformer arranged to avoid hum.

5. Large transformers and smoothing chokes should be kept as far away as possible from pickups and tape heads, and positioned for minimum hum by trial and error. In really bad cases a mu-metal cover may be necessary.

Hum Frequency. The frequency of hum may be at 50 c/s or 100 c/s according to its origin. (60 c/s or 120 c/s in the U.S.A.)

With 50 cycle mains, amplifier hum would occur at 100 c/s and if rather strong would cause modulation of higher frequencies. For instance, the intermodulation products at 1,000 c/s would be 1,100 c/s and 900 c/s, although the audible hum would probably be the greater nuisance.

Pickups and Turntables. When disc stereo hit the audio world between the eyes (or in one eye only) early in 1958, many enthusiasts ran into serious hum trouble due to extra windings in some stereo pickups which picked up a lot of hum from turntable motors, which varied enormously in the stray fields produced.

Manufacturers have paid serious attention to this problem and it is now possible to buy first-class equipment which is reasonably hum free.

HUM-BUCKING COIL Where it is impossible to shield low level wiring adequately from hum fields, it is sometimes practicable to cancel the spurious hum by deliberately introducing hum at some other point in the circuit in antiphase by using a small hum-bucking coil.

HYPEX HORN This is the hyperbolic shape illustrated in Fig. E/9 and gives superior low frequency performance because the acoustic resistance at throat is higher than other types as shown in Fig. H/5.

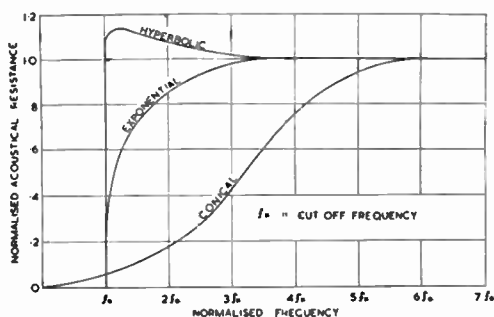

FIG. H/5. Acoustic resistance at horn throat for various flare shapes.

HYSTERESIS In magnetic materials, the relationship between magnetomotive force and induction follows a different law according to whether the magnetomotive force is increasing or decreasing. This phenomenon gives rise to the well known hysteresis loop shown in Fig. H/6. The area of the loop represents the energy expended in magnetising the material to saturation in one direction and then the other.

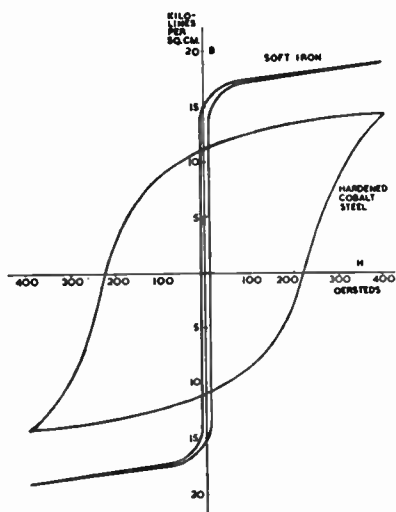

FIG. H/6.

Hysteresis loops.

In materials such as transformer cores which are subjected to continual magnetic reversals, hysteresis accounts for a substantial portion of the wasted power.



I.E.C. International Electrotechnical Commission,
1 rue de Varamb , Geneva, Switzerland.

The object of the Commission is to facilitate the co-ordination and unification of national electrotechnical standards and to co-ordinate the activities of other international organisations in this field.

I.P.S. Inches per second, sometimes expressed as "/sec or in/sec, this refers to the speed at which the tape passes the recording head in a tape recorder.

Master tapes by recording companies are usually run at 15"/sec, but the 30" speed is still used by one or two companies. For high-class domestic use 7½"/sec is satisfactory, 3¾" works quite well, but 178" (in the present state of development) is more suited to speech than music.

As tape speed is reduced—other things being equal—the following effects occur because, as usual in this life, you can't have it both ways:

DEBIT SIDE

1. More wow and flutter;
2. Reduced HF response;
3. Poorer signal to noise ratio;
4. Tape drop-outs more pronounced;
5. Editing more difficult.

CREDIT SIDE

1. Less abrasive wear;
2. Longer playing time with lower cost per hour of output, although many would prefer half an hour of good reproduction to an hour of second-rate stuff.

Performance at slower speeds is constantly being improved, but the fact remains that the same techniques applied to the higher speeds attain still higher standards.

Naturally, a first-class machine at $3\frac{3}{4}$ " /sec could out-perform a second-class $7\frac{1}{2}$ " /sec model.

IMPEDANCE In an ac circuit, capacitance, inductance and resistance all impede the flow of current. The combined effect, measured in ohms, is known as impedance.

In loudspeakers, the impedance varies with frequency and this applies in varying degrees to all types, including moving coils, crystals and electrostatics. Some idea of the variety of impedance curves which crop up can be gleaned from the following illustrations:

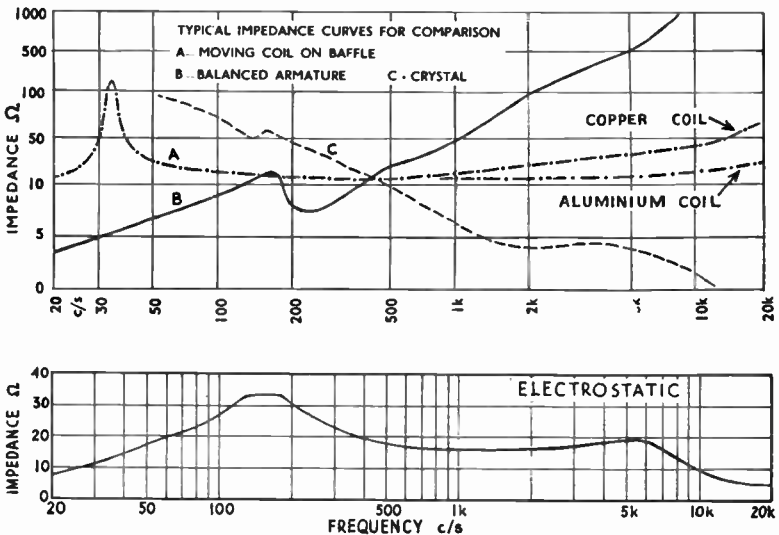

FIG. 1/1. Typical impedance curves.

In moving coil speakers, the impedance rises in the bass due to cone and enclosure resonances and in the treble due to the inductance of the voice coil. Fairly level results can, however, be obtained by parallel working. See Fig. 1/2.

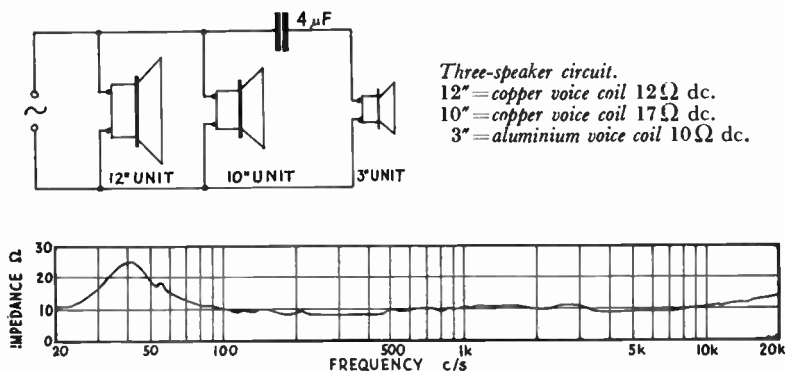

FIG. 1/2. Unusually level impedance curve achieved by parallel working.

Maximum transfer of power with minimum distortion takes place when the impedance of the loudspeaker (apart from phase angle, q.v.) matches the output impedance of the amplifier, but thanks to NFB and low internal impedance of amplifiers, distortion from mismatching has been greatly reduced. Even a 3 ohm speaker can be used on a 15 ohms output without noticeable distortion within the reduced power limits which result from the mismatching.

Pickups. To obtain the best performance, the input impedance of the preamp must be arranged to suit the pickup. With some moving coil types, a step-up transformer is necessary.

General requirements are covered under Pickups, but the makers usually give detailed instructions.

Microphones. Here again load matching is important. Some high quality condenser types include one valve stage in the mic. case to avoid trouble with high impedance lines.

Tape Recorders. When using a bigger and better external speaker with the built-in amplifier, reasonable load matching is advisable to avoid loss of power. If the difference is as much as 3 to 15 ohms, a matching transformer is worth while.

Line Impedance. The advantages of working at low impedance with input or output circuits are that the capacitance of the leads has negligible effect and there is little tendency to pick up hum.

The only trouble is the resistance of the wire. If this is less than one-third of the impedance of the circuit, measuring the two leads in series, *not* in parallel, the loss in power will be acceptable for domestic use. For professional standards, the line resistance would be limited to about one-fifth of the load impedance.

INDUCTANCE The ability of a circuit to store electrical energy in a magnetic field is called self-inductance. The unit is the henry and a circuit having an inductance of 1 henry will store $\frac{1}{2}$ joule of energy when a current of 1 amp is flowing.

The current flowing in a 1 henry inductor creates a self-induced back emf of 1 volt when the current is changing at the rate of 1 amp per second.

Inductance can also occur in circuits which, though electrically isolated, are coupled magnetically. This is called mutual inductance.

INDUCTION MOTOR A type of electric motor widely used in tape recorders and for driving gramophone turntables. Its operation is limited to ac but its speed is substantially independent of voltage fluctuations.

The speed is governed by the number of poles and the rotor runs at just below synchronous speed. A two-pole type runs at about 1400 rpm on 50 c/s whilst a four-pole motor runs at about 700 rpm.

INDUCTOR A device having a high proportion of inductance. Typical examples are transformer windings and chokes.

INFINITE BAFFLE Wall mounting of a loudspeaker gives the only true infinite baffle. The first I ever came across was on a visit to Baker's Selhurst about 1932 when I heard a 12" moving coil speaker mounted in a wall, reproducing piano music in a way which came as a revelation to me at the time. (I can still hear the natural tone quality.)

Small total enclosures are sometimes referred to as infinite baffles but this is a misnomer. They are very convenient in use and judiciously placed fundamental resonance produces remarkably good bass, but enclosure resonances find their way to the listener's ear—mainly through the cone—and as internal volume is reduced, more and more sound absorbent material must be used. On the other hand, the incidence of panel resonance is reduced with size, so you gain on the swings a little of what you lose on the roundabouts.

INSERTION LOSS The use of any passive network is always accompanied by some loss of power caused

by dissipation in the various elements. The wasted power is referred to as insertion loss.

With loudspeaker crossover networks, the loss varies between 0.3 dB and 1.5 dB depending on crossover frequency and number of elements. The drop in output is actually not noticeable to the ear.

INSTABILITY In well designed amplifiers, this fault is a thing of the past because any good make is now guaranteed stable under all or any load conditions.

Three main forms of instability have been common, particularly in the early days of NFB. These were:

- (a) Motor-boating;
- (b) Continuous oscillation at a supersonic frequency;
- (c) Sudden oscillations triggered off by a transient or by turning up the treble control.

Fig. I/3 shows that a combination of motor-boating and parasitic oscillation can produce a nice picture on the 'scope but the results on programme are rather devastating.

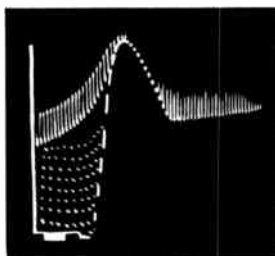

FIG. I/3. *Picture of combined effect of motor-boating and parasitic oscillation on steady tone at 1,500 c/s, showing severe intermodulation.*

Oscillation can occur at a frequency as high as 150 kc/s and could damage output valves, transformer, or voice coil winding of a loudspeaker, and may be induced by excessive NFB.

No self-respecting amplifier would allow itself to be passed for general use without prior inspection by oscilloscope.

INSULATORS All substances conduct electricity; solids, liquids and gases. The ease with which they conduct depends upon atomic construction, purity, temperature and atmospheric conditions.

Materials which freely exchange electrons are good conductors. Typical examples are silver, copper and gold. Substances which cannot exchange electrons between their own atoms except with great difficulty are classed as insulators. These include porcelain, mica, rubber, and many kinds of plastic such as PVC and nylon.

Paper and wood are greatly affected by humidity. Glass is a good insulator at normal temperatures but becomes conductive when red-hot.

There is no clear division between conductors and insulators and much depends upon the job in hand. For instance, wood may

be satisfactory in a low-voltage bell circuit but certainly dangerous when carrying 240 v mains.

INTERFERENCE This trouble with radio reception in Great Britain has been greatly reduced by the almost nation-wide coverage by FM transmitters. In the writer's case, bedlam on AM was replaced by 90% silent background with FM, the only interference being occasional car ignition plops and mains-borne disturbance. This latter nuisance has been curtailed during recent years by the use of suppressors, and Post Office engineers are always willing to track down really bad interference. Those who have a serious problem should report to the local Post Office.



FIG. I/4.

Local interference.

"Grandma wants one that isn't suppressed - she hates television!"

INTERMODULATION If two or more frequencies are fed into a non-linear circuit or transducer, harmonics of the fundamentals with sum and difference tones will be produced. This is intermodulation distortion. It is usually caused by over-loading.

The trouble can be avoided in loudspeakers above a certain frequency range by using two speakers and a crossover network, although it is not often heard on good equipment today, except perhaps on loud organ passages.

Amplifier Test. Tests are often made at 60 c/s and 2,000 c/s, with the low frequency at 12 dB higher level than the high frequency. To test an amplifier down to 30 c/s, this frequency would have to be taken in place of 60 c/s. The intermodulation product is about four times as high as the distortion factor, and gives a good idea of the quality of the amplifier.

IONOPHONE Invented by Sigmund Klein of Paris, the Ionophone is unique because it does not depend on moving parts for its reproduction of sound, the source being a radio frequency corona discharge inside a small quartz or hard glass tube opening to the air through an exponential horn. Although capable of almost perfect performance at high frequencies, efforts to produce the Ionophone commercially in France and England have not met with success.

J

JOULE The practical unit of electrical energy named after the English scientist James Prescott Joule, 1818-1888.

1 joule=10 million ergs.

JOHNSON NOISE A sizzling or frying sound of indefinite pitch produced by thermal agitation of electrons in resistors. In audio equipment this noise always arises in the input circuit and is a function of circuit resistance and frequency range. For this reason amplifier input impedance should always be kept to a minimum and good quality cracked carbon resistors should be employed in low level circuits.

JOURNALS Names and addresses included for handy reference.
Great Britain—

AMATEUR TAPE RECORDING (Monthly)

British Recording Club, 145 Fleet Street, London E.C.4

THE GRAMOPHONE (Monthly)

Gramophone Publications Ltd., The Glade, Green Lane, Stanmore, Middlesex

GRAMOPHONE RECORD REVIEW (Monthly)

Record Review Ltd., East Hill, St. Austell, Cornwall

HI-FI NEWS (Monthly)

Miles Henslow Publications Ltd., 99 Mortimer Street, London W.1

POPULAR HI-FI (Monthly)

British Recording Club, 145 Fleet Street, London E.C.4

SOUND RECORDING AND REPRODUCTION (Quarterly)

British Sound Recording Association (Editor: James W. Godfrey), Friends Bungalow, Long Sutton, Longport, Somerset

TAPE RECORDING AND HI-FI MAGAZINE (Fortnightly)

Print and Press Services Ltd., 7 Tudor Street, London E.C.4

WIRELESS WORLD (Monthly)

Iliffe and Sons Ltd., Dorset House, Stamford Street, London S.E.1

U.S.A.—

AUDIO (Monthly)

Radio Magazines Inc., P.O. Box 629, Mineola, New York

ELECTRONICS WORLD (Monthly)

Ziff-Davis Publishing Co., 1 Park Avenue, New York 16,
New York

HIGH FIDELITY (Monthly)

The Publishing House, Great Barrington, Massachusetts

HI-FI AND MUSIC REVIEW (Monthly)

Ziff-Davis Publishing Co., 366 Madison Avenue, New
York 17, New York

HI-FI STEREO (Monthly)

Ziff-Davis Publishing Co., 1 Park Avenue, New York 16,
New York

JOURNAL OF THE ACOUSTICAL SOCIETY OF AMERICA (Monthly)

57 East 55th Street, New York 22, New York

JOURNAL OF THE AUDIO ENGINEERING SOCIETY (Quarterly)

P.O. Box 12, Old Chelsea Station, New York 11, New York

RADIO-ELECTRONICS (Monthly)

Gernsback Publications Inc., 154 West 14th Street, New
York 11, New York

K

KILO Derived from the Greek *khilioi*, the French word kilo means a thousand and is commonly used in English along with cycle to denote 1,000 vibrations per second. The term kilocycles per second is abbreviated to kc/s.

KLIPSCHORN Developed by Paul W. Klipsch and described in the *Journal of the Acoustical Society of America* in October 1941, and in January 1946, the Klipschorn uses a front-loaded 15" unit for bass, with a special form of horn loading for the treble unit, and a crossover at about 500 c/s.

In the ingenious LF horn, the sound waves are reflected back so that they emerge from the two sides of the device, which fits into the corner of a room, the walls acting as extensions to improve the impedance match at the mouth. Frequencies as low as 28 c/s can be well reproduced.

The treble unit plays into a multi-cell horn arrangement for a short distance, followed by a single horn expansion in a different plane designed to maintain response down to the cut-off frequency of the bass section, with wide angle distribution.

The efficiency of the system is extremely high. A couple of Klipschorns for stereo, with a treble unit added to fill in the middle, would give very good results.

L

LF Low frequency. Say the two bottom octaves of the piano, about 100 c/s downwards.

LACQUER DISC Aluminium or glass disc coated with cellulose nitrate, originally used by Cecil Watts in 1927/8, and now generally preferred to wax.

All commercial recordings are first made on tape, and a lacquer disc is then cut as the first step in the process of record production, which includes lacquer original, master, mother, stamper and finally pressing.

We have on occasion used lacquer originals for concert hall demonstrations. For quiet background and purity of tone they are a delight, and can be used many times with ultra lightweight pickups without noticeable deterioration, although one playing at 10/12 grms would just about wipe the platter clean.

LATERAL RECORDING This knocked out vertical or hill and dale recording about 70 years ago and has held on to the record ever since.

LEAKAGE INDUCTANCE In a practical transformer, the magnetic flux lines generated by the primary do not all link with every turn of the secondary winding, and vice versa. This causes a loss at high frequencies just as though a small inductor were connected in series with the transformer.

Where good HF response is required, the leakage inductance must be kept low, and this becomes more difficult as transformer size is increased. Coupling between primary and secondary is improved by using several side by side sectional windings, and in some cases by adopting bifilar winding described under B.

In a good output transformer, the leakage inductance should not exceed 0.2H, but for really first-class HF results the value should not be higher than 0.01H.

LEVEL The strength of a signal. In strict parlance, level refers to the strength of a pure tone relative to a specified zero, generally 1 milliwatt into 600 ohms.

LIGHTNING Although not directly related to Audio, the effects of lightning are often noticed and—as with electricity—many people are in doubt as to the risks involved. We have therefore put a few questions to Mr. Price, and we begin by

illustrating the artificial lightning already referred to under Electricity. The photos show three aspects of electrical discharges at more than 100,000 volts between points 7" apart.

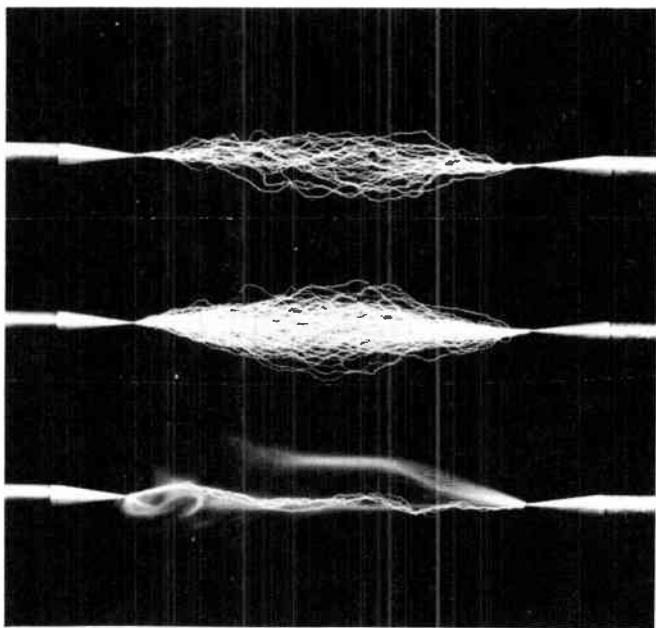

FIG. L/2. *Artificial lightning produced in the Bradford Institute of Technology.*

Now for the questions:

Q. *What is lightning?*

A. Lightning is a discharge of electricity between two clouds, between parts of a cloud, or between a cloud and an earthed object.

Q. *How many volts are normally generated?*

A. Some millions.

Q. *What is thunder?*

A. Thunder is the noise caused by lightning due to the disturbance of the air in the path of the spark.

Q. *About how far away can we hear thunder?*

A. In certain circumstances thunder can be heard at distances of over thirty miles, the sound waves being refracted in the atmosphere in the same way that radio waves are refracted in the Heaviside or Appleton layers.

Q. *If you can see flashes of lightning and hear thunder almost at once, are you in the danger zone and would you disconnect aerials?*

A. Yes; this would be a reasonable precaution.

- Q. *Does a TV aerial act as a lightning conductor and attract a hit?*
 A. To some extent, but a house can be hit without an aerial. (N.B.—Lightning conductors are known as lightning arresters in America.)
- Q. *To what extent do lightning conductors offer protection?*
 A. A stout lightning conductor with a direct connection to a good earth protects an area around itself from a direct hit by attracting the hit to the lightning conductor. A flimsy lightning conductor will evaporate if struck, and the “protected building” would then have to bear the resultant damage.
- Q. *What is the extent of this area of protection around the lightning conductor?*
 A. It depends on circumstances, but a radius of about four times the height of the conductor is a reasonable estimate.
- Q. *Many years ago we supplied relay loudspeakers with voice coils wound in 46 gauge wire. Every time there was a thunder-storm a few of these voice coils would be burnt out, although the house in which they were being used was not struck by lightning. Why?*
 A. Because an impulse of electricity is produced by the lightning stroke, and this travels along the relay wires and so may enter a house, and burn out the loudspeaker connected to the wires.
- Q. *Would a similar minor shock affect TV or radio during a storm via an aerial?*
 A. Only if the aerial suffered a direct or near hit.
- Q. *Then the fact that during a distant storm you see flashes on your TV set does not mean that you or the set are running into danger?*
 A. The flashes are caused by radiated interference from the lightning flash picked up by the set, and are no more dangerous than the “snowstorms” seen as a result of interference from motor-car ignition systems or other electrical apparatus.
- Thank you, Mr. Price.

LINEAL MEASURE

LINEAL MEASURES

	<i>in.</i>	<i>ft.</i>	<i>yd.</i>	<i>cm.</i>	<i>metre</i>
1 inch	1	0.083	0.028	2.54	0.025
1 foot	12	1	0.333	30.48	0.305
1 yard	36	3	1	91.44	0.914
1 cm.	0.394	0.03	0.01	1	0.010
1 meter	39.37	3.281	1.094	100	1

LINE SOURCE LOUDSPEAKER The radiating pattern of this type of speaker has been depicted in Fig. D/6 and is useful in schools, halls or churches where acoustic conditions are often difficult and reverberant. The sound reflected from walls, floor and ceiling is kept down to a minimum and intelligibility on speech is improved by facing the loudspeaker towards the audience.

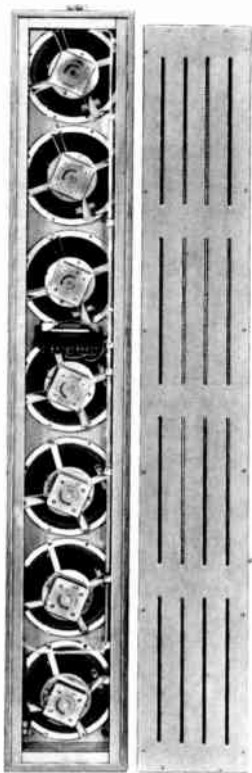

FIG. L/3.

If all the units in a line source loudspeaker are fed with equal power, the radiation pattern will contain large spurious side lobes. Cleaner results can be obtained if the power input to each unit is attenuated progressively as its distance from the centre increases.

A rear view of such a speaker system, with special back removed, is given in Fig. L/3.

Due to the special form of air loading on back of cones, the line source is better on speech than music, and due to the number of speaker units in use, the power handling capacity is very high. With seven units rated at 3-5 watts each, peak inputs of 20 watts can be safely tackled. Only last week the writer was attending a cricket match when an announcement was made to a crowd of some 6,000 spectators through a single line source speaker assembly. The clarity was excellent and the entire area of about four acres was easily covered; in fact, there was considerable overthrow, or should we say that the announcer hit more sixes than fours.

LISTENER FATIGUE Reproduced sound fatigues the listener more quickly than does a live performance, due partly to imperfections and unnatural effects in the reproduction, and also to absence of the dynamic effect of actually watching the performance.

It would seem to be reasonable to conclude that the most nearly perfect loudspeaker is the one which produces the least fatigue in the listener, but under small room conditions a touch of top cut may come as a relief, especially to the tired housewife.

LISTENING TESTS In audio, there is nothing more important than a listening test, which is equivalent to looking at a picture, although we are fortunate that audio is not complicated by surrealism and the ultra-modern touch. (I think we can safely rule out *musique concrète*.)

The three most important considerations in listening tests are:

- (1) variety of programme;
- (2) acoustic conditions of listening;
- (3) location of loudspeaker.

The fact that we all hear differently is something that cannot be helped.

Let us deal briefly with the three ruling conditions.

(1) The presence of resonances in transducers and formant tones in voices and musical instruments make it essential to ring the changes as much as possible. Different voices should be heard, and test records should include organ, piano, orchestra, chorus and dance band for a complete assessment of frequency range, transient response and coloration.

(2) It is easy enough to talk about listening-room conditions, but it is difficult to get over their effect. When listening in show-rooms and audio fairs the only thing to do is to try to discount room effects and imagine how the reproducer would sound in your own room at home, which is more easily said than done.

(3) The location of a loudspeaker can obviously be adjusted by moving it about, unless it belongs to the corner variety or is in the concrete or bricks and mortar family.

The main things to remember are that a corner, or a position near the wall facing the longest length of the room, gives the most bass, and with directional speakers there is an enormous difference between listening on axis and stepping to one side, or merely standing up instead of sitting down.

Controls. When comparing loudspeakers seriously, there should be no fiddling with controls.

Sensitivity. Impedance matching to amplifier cannot be ignored here. For example, an 8 ohm speaker connected to the 15 ohms output of an amplifier will sound louder than a 15 ohm model of the same type, but the *maximum* power output will be reduced as a result of the mismatching.

LIVE v. RECORDED There can be little doubt that an immediate comparison between live and recorded performance is one of the best ways of judging the quality of reproduction.

It must have been the year 1933 or 1934 when I heard my first demonstration of this type, put on by P. G. A. H. Voigt. One of his assistants gave a reading of poetry "live" and then reproduced through a "Tractrix" horn.

In 1938, Mr. Shorter of the B.B.C. Research Station—then at Balham—told me that he made a practice of testing all loudspeakers by comparing reproduced speech with the actual voice, sometimes in the open air away from all room effects, and I am sure that Mr. Shorter still attaches great importance to this method of detecting faults and resonances in transducers.

Other demonstrations of live and recorded music that I have heard include very good efforts by H. J. Leak, P. J. Walker, F. H. Brittain of G.E.C., C. E. Watts with his 'cello, and Mullards. It suffices to say that the principle has been long established in this country and the U.S.A.

The writer's first experience of public demonstrations of live and recorded music was on the 25th of March, 1954, in St. George's Hall, Bradford, when an audience of 1,400 turned up (admission free!) to hear a programme of records, including some very scratchy 78 rpm shellacs, and piano solos by Edgar Knight compared with commercial LP records of the same works made by Columbia and Decca.

Mainly for sentimental reasons a photograph of the platform taken on that occasion is reproduced in Fig. L/4. It astonishes me today to note that this event was put on with one 15 watt Quad II amplifier, with a single 3-speaker assembly, and no reserves in case of breakdown, all equipment on the platform, and an accomplice at the back of the stalls to give us signs to play louder or softer with more top or bass, as each item came through. Although definitely short of power on records of chorus, orchestra and organ, other items such as piano, solo voice, trio and dance band were adequately dealt with.

I seem to remember that one of the highlights of the evening was a record of Thames Tugboat noises, which we played most effectively by pushing 30 watts out of the 15 watt amplifier. (There's nothing like a bit of distortion for giving life to noise effects.)

The small and rather weird looking loudspeaker on the left of the platform should be ignored. It sounded dreadful and was not used during the concert. Incidentally, this acoustic orphan gave us our first lesson in the value of concert hall conditions in assessing loudspeaker performance.

Note the artificial corner placed behind the 3-speaker corner system to enable it to live up to its name. This was not used at subsequent demonstrations because the panels were not big enough to be effective at low frequencies, and we found that a better method of throwing the HF sound into large halls was simply to tilt the treble units at a suitable angle. (We all live and learn.)

During the following six years we gave no less than twenty concerts at which live and recorded items were compared, including four in the Royal Festival Hall, London, and two in Carnegie Hall, New York, most of them with the valued collaboration of Peter Walker and John Collinson, two men possessing technical



FIG. L/4. *St. George's Hall, Bradford. Demonstration 25th March, 1954. Edgar Knight at the piano. W. S. Escott at the controls. (The old man on the left prefers to remain anonymous.)*

knowledge and skill along with musical and artistic taste.

Looking back briefly over this field of audio activity, the following points strike me as the most interesting.

Cost. It appears to be impossible to make a profit on such events. In provincial cities, with an admission charge of 3s. average, our nett loss came out at about £150 per concert. In the R.F.H. with nearly 3,000 in the audience at about 3s. 6d. each, the loss averaged £250 per concert.

In Carnegie Hall, the first demonstration left us £1,250 in the red, and the second, which was promoted in true American style, achieved the astonishing result of £3,000 nett loss, not including my expenses in getting there and returning home! Audience about 2,400, average admission price 12s. 6d. each.

The point here is that if people are interested they will come to demonstrations with the minimum of publicity. Extra advertising to draw bigger crowds is a dead loss.

For me, the most enjoyable incident was one which occurred after our first Carnegie Hall concert, when we went along to WQXR radio station in New York to be interviewed, with Mrs. P. J. Walker looking on from the distinguished stranger's ante-room.

The announcer introduced Mr. Walker to the listening multitudes as my assistant! This made my day.

Recordings. Almost the whole secret of success is to select the right type of recording, the main quality being the degree and nature of the included ambience. In a large, acoustically-treated hall, a little bit of ambience goes a long way, and the better the hall, the more careful you have to be.

Controls. Next to recordings, the man at the controls has the fate of the concert in his hands. Correct volume level is far more important than tone controls and the O.C. must be located in a good listening position in the hall. All the assessments of volume level must be done by ear; sound level meters are useless for the purpose.

No amount of fiddling with bass or treble will make up for incorrect volume levels, and it is impossible to reproduce naturally in a very large hall small sound effects such as running water, a musical box, or grasshoppers, because by the time they are made loud enough to reach the back of the hall they sound like a travesty of the original.

Amplifiers. Overload distortion on musical items must obviously be avoided like the plague, but we have never used more than four 15 watt amplifiers at any demonstration.

Hum, rumble, surface noise and hiss. These must be kept down to a minimum because their nuisance value seems to increase as the square of the size of the hall and audience.

Loudspeakers. The best position on platform should be found by listening tests. Adding an extra speaker (or speakers) often reduces hall resonance effects. For live *v.* recorded comparisons, the artist(s) and the loudspeakers should be as close together as possible, both tonally and physically.

Musicians. We have always had whole-hearted co-operation from artists and at reasonable fees. As a matter of fact, in Carnegie Hall, we actually paid more to the porters who shifted our equipment than we paid the artists who performed for us.

We have never found artists unduly temperamental, although we ran into a bit of trouble in St. George's Hall, Bradford, in 1955, when we attempted two-channel recording for the first time, using staggered heads on the tape machine. At the playback, the heads were somewhat out of adjustment and I must admit that Léon Goossens showed distinct signs of annoyance when the piano kept on coming in a quarter of a second after the oboe. (To me, it

sounded like a posthumous performance by Paderewski.) However, an adjustment to the tape heads soon restored Mr. Goossens to his normal, charming composure. Incidentally, this early stereo recording by Arnold Sugden was very good, which brings us nicely to the next sub-heading.

Stereo. Although stereo records are made with a view to replay in small rooms, I consider that we have had some excellent results in concert halls, with very good live/recorded comparisons on organ, oboe, bass voice and trio. Listening to a tape recording of the events, the stereo items come through as a rule better than the monos, and there is no more searching test of reproduction of sound than studying a re-recording.

Audiences. One should never under-rate the intelligence and judgment of an audience. The aforementioned tapes show how well they usually show appreciation of what is best in a programme. (Unfortunately, they always *remember* the worst items and the mistakes.)

LOUDNESS The loudness of a sound is its intensity as judged subjectively by the human ear. Although loudness depends primarily on actual intensity, it is also strongly affected by frequency as shown by Fletcher and Munson.

LOUDNESS LEVEL The loudness level of a sound expressed in phons is numerically equal to the sound pressure level in decibels ($0\text{dB}=0.0002$ dynes per square centimetre) of a pure 1 kc/s tone which is judged by the human ear to be equally loud.

LOUDNESS CONTROL As the volume of a sound is reduced, the low frequencies diminish in loudness more rapidly than middle frequencies. Treble is similarly affected though to a smaller degree. Thus when the volume is turned down, music tends to sound thin and emaciated. The effect may be counteracted to some extent by bass and treble boost in the amplifier.

A loudness control is a device which automatically applies bass and treble boost as volume is reduced, the amount of boost being adjusted in accordance with the Fletcher Munson curves.

This type of control has proved popular with American amplifier manufacturers for several years but has never really caught on in Great Britain. Its principal disadvantage lies in the fact that low volume with tone correction cannot simulate the effect of distance which is always accompanied by increased reverberation at the ear of the listener. Also, when an instrument is played more quietly its harmonic structure alters. In short, music reproduced very softly can be a pleasant background but not much more.

LOUDSPEAKER A loudspeaker is a transducer for converting electrical impulses into sound waves, the main problem being to do it with equal efficiency at all audio frequencies, without introducing resonances.

A rather devastating description came to us from Mr. J. Weston of Peacehaven, who wrote in to say that his little boy, aged five, always refers to them as loud-peakers. (Out of the mouths of . . .)

The basic difficulty with loudspeakers is that low frequencies require large cones, diaphragms, baffles, enclosures, horns, etc., for their well-being, whereas high frequencies thrive on small driving systems.

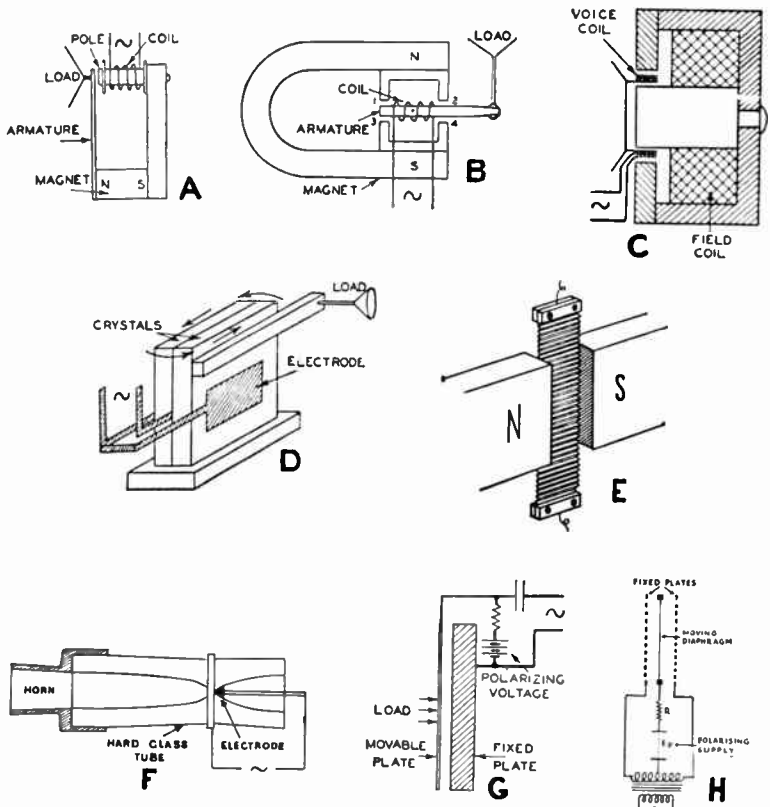

FIG. L/5. Driving Systems.

- A—Moving Iron.
- B—Balanced Armature.
- C—Moving Coil.
- D—Crystal.
- E—Ribbon.
- F—Ionophone.
- G—Single-sided Electrostatic.
- H—Push-pull Electrostatic.

Figs. A, B, C, D and G from Olson. Fig. E from Wireless World

There are at least sixteen known methods of making these electro-acoustic devices, but only half of them have had any commercial application and these are illustrated in Fig. L/5.

The most widely used is the moving coil design because of its efficiency, versatility, low cost and reliability. Some ribbon treble speakers are still being produced, and there has been a lot of interest in push-pull electrostatics for full range as well as treble reproduction during the last few years, but the moving coil still dominates the market.

Although the manufacture of loudspeakers is quite a big industry today, it is not one of the easiest in which to succeed, because the product is expected to make a pleasant noise during many years of active service. Since 1930, no less than 20 manufacturers have given it up as a bad job in this country alone, leaving about half that number still active in the field. (The odds against success appear to be 2 to 1 or are they 3 to 1?)

Quite recently, a moving coil speaker which is 30 years old was presented to us by a B.B.C. engineer, Mr. J. Potter of Stockport. This was made by Ormond Engineering Co., and the cone has a leather surround with a bass resonance at 90 c/s. The unit sold at 65s. complete with matching transformer and is illustrated in Fig. L/6.



FIG. L/6.

Ormond moving coil speaker made in 1930 and still in good working order.

On a listening test the Ormond acquitted itself remarkably well with a deficiency of "top" according to modern standards, so we ran off a response curve and this is shown in Fig. L/7, with a curve of an up-to-date 10" unit in Fig. L/8 for comparison.

The result of thirty years' progress seems to boil down to extending the frequency range by about three octaves, say one octave per decade. Not very impressive?

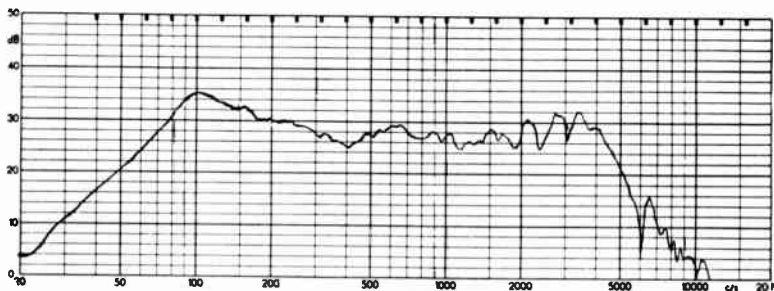

FIG. L/7. Axial response of 1930 model. Bass resonance 90 c/s.

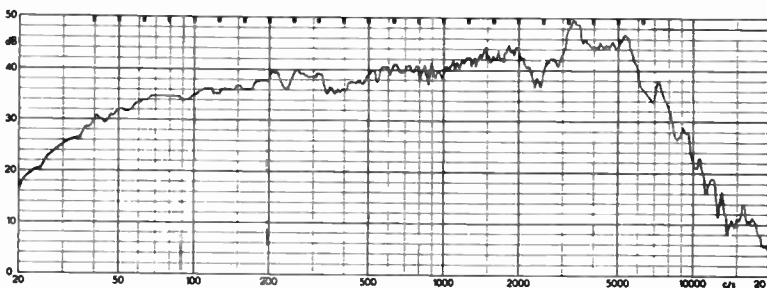

FIG. L/8. Axial response of modern 10" speaker. Bass resonance 35 c/s.

LOW PASS FILTER An electrical network which attenuates all frequencies above a predetermined point of the audio range.

L PAD A type of attenuator or volume control having two variable resistance elements as shown in Fig. L/9.

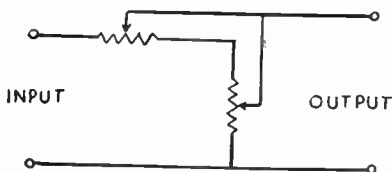

FIG. L/9.

Constant impedance volume control in the form of an L pad.

This type of control is often used in low impedance loudspeaker circuits. The two movable arms are adjusted to keep the input impedance constant as the volume is varied.

M

M.B.S. Mutual Broadcasting System, Inc., U.S.A.

M-S The M-S system is a microphone arrangement used for stereo, invented by the late Holger Lauridsen of the Danish State Broadcasting Corporation.

One of the best definitions of M-S recording we have come across was given by Donald Aldous in *Gramophone Record Review*, so rather than think it all out again we are repeating his summary verbatim:

“German Mitte-Seite, or Middle-Side system. An important stereo recording technique, usually employing a special German Neumann SM-2 microphone, which contains two capacitor (condenser) elements in one housing. The polar characteristics of these units are variable by voltage adjustment of the power supply. The mid-microphone is given a cardioid polar characteristic and oriented directly toward the sound source; the side microphone is given a figure-8 polar characteristic, oriented parallel to the sound source.

“The mid-microphone picks up all the sound, $L+R+C$, with C representing the centre. The side microphone receives primarily L and R, but the signal produced is not $L+R$, but $L-R$, according to the phase of the signal on the one transducing element. These signals are combined in special output transformers, incorporated in the microphone, in the following manner. $L-R$ and $L+R+C$ signals are connected in series in phase, producing $2L+C$. The $L-R$ signal is fed off out-of-phase to become $R-L$, which is again combined in series with $L+R+C$ to produce $2R+C$. This means that one channel contains information mainly from the Left, and the other contains information mainly from the Right, but each also contains information representing the centre of the sound source.”

MAGIC EYE A small cathode ray tube in which the brightness or area of the fluorescent screen varies in accordance with an applied signal voltage.

The most popular types of magic eye incorporate an amplifying valve within the same envelope so that they will operate from a relatively small input voltage. They are widely used as amplitude indicators in medium price tape recorders and as tuning indicators in radio receivers, being particularly worth while in VHF sets because exact tuning is critical and difficult.

MAGNET The predominant use of permanent magnets in audio engineering is obviously in moving coil loudspeakers.

The main lines of development during the last 30 years have been to increase the magnetic efficiency of current alloys and to produce new types of magnet materials.

The energy supplied by a 5 lb. chrome magnet in 1932 can now be achieved by an Alcomax plug weighing only 2¼ oz.

In very recent years much development work has been done on the commercial production of ceramic magnets of the barium ferrite type, which have low raw material costs and which are strategically available in this country.

These ceramic magnets can be moulded to reasonably accurate dimensions and have been widely used for cathode ray focusing, cycle dynamos, door catches, etc. They are used in the U.S.A. and in Germany for loudspeakers, but exploitation in this direction has been hampered by the fact that the lower cost of the magnet material is off-set by higher tool charges and more expensive mild steel parts, so large quantities of a given design must be ordered to achieve any economy over the older designs and materials. Naturally, any violent fluctuations in the world price of cobalt will be likely to influence the situation, whilst the ease and speed with which small quantities of special designs in Alnico and Alcomax can be produced means that these types are far from becoming obsolete in the loudspeaker field.

MAGNETIC RECORDING The first magnetic recorder was invented by Valdemar Poulsen in Copenhagen in 1899. Known as the "Telegraphone", his invention was intended for recording telephone messages automatically, as well as for use as a phonograph.

Poulsen described methods of magnetising wire, steel tape, or paper tape coated with metallic powder. The recording could be wiped off electrically and the tape or wire used over and over again. The system was later improved by Stille, and the Marconi-Stille machine employing steel tape was the first recording system to be used by the B.B.C.

Magnetic tape is now the order of the day, and is very widely used in sound and vision recording and in film sound tracks.

Magnetic recording can also be made on disc coated with magnetic emulsion, but so far this does not constitute a threat to the mechanically-cut groove, apart from dictating machines.

MAGNETOMOTIVE FORCE This is the force which produces magnetic flux in a magnetic circuit. It is analogous to electromotive force in an electrical circuit.

The unit of magnetomotive force is the gilbert in the cgs system; one ampere turn produces 1.257 gilberts.

MASKING When two tones of different frequency are produced, increasing the power of one of them may render the other inaudible. This is known as masking, but only occurs where the tones are fairly close together in pitch, say within a couple of octaves or so, and where one tone is at least 10 dB louder than the other.

MASS The quantity of matter in a body. Mass is often confused with weight but there is a difference in that the mass of a body is constant whereas its weight, which depends upon gravitational pull, will vary over the earth's surface. The unit of mass in the cgs system is the gramme.

MATCHING When two pieces of audio equipment are connected together so that power flows from one to the other, their performances will be affected by the impedance relationship. Impedance matching influences power output, frequency response, distortion and damping, but the conditions necessary for optimum power transfer may not coincide with those required by other considerations and matching is usually a matter of compromise.

Power Transfer. Maximum power is transferred from generator to load when the load impedance is the conjugate of the generator output impedance, i.e. equal in magnitude but opposite in phase. This optimum condition is sometimes achieved in matching a driver unit to a short horn.

Frequency Response. As a general rule, it is better to feed from low impedance to high, rather than vice versa.

Pickups need careful attention here. With variable reluctance types, too high a load impedance will produce a peak in the region above 10 kc/s, whereas too low an impedance may actually lose top response. With crystal pickups, things tend to work the opposite way round.

Distortion. With amplifiers, impedance *v.* distortion in the loudspeaker only becomes a major consideration where very high power is involved. Distortion risks are reduced by making the load impedance rather high and sacrificing a little of the power output.

Damping. As everybody now knows, good electromagnetic damping is achieved by making the internal impedance of the amplifier much lower than the normal impedance of the loudspeaker, thanks to the amplifier maker's Alma Mater, NFB.

MAXWELL The unit of magnetic flux in the cgs system. It is named after James Clerk Maxwell (1831-1879), the Scottish physicist who laid the mathematical foundations of modern radio theory.

In permanent magnet terminology, the important values of total flux are referred to as maxwells. In the commercial sphere, anybody who bought permanent magnets and ignored the number of maxwells would have to be mentally examined.

MEGA Meaning one million. Thus one megaton equals one million tons, and a megohm is one million ohms.

MEGAPHONE A large speaking-trumpet, originally devised by Edison for projecting a voice a long distance in the open air without the aid of wires or electricity.

A modern version by Tannoy is illustrated in Fig. M/A, and is used in police and sports activities, emergency services, film studios, civil engineering, etc.



FIG. M/A. *Modern megaphone complete with mic., transistor amplifier, volume control and re-entrant horn loud-speaker, capable of magnifying the human voice 100x.*

MEGGER A small, hand-cranked voltage generator used for measuring leakage in electrical equipment, insulation between windings and core in transformers, and similar purposes. Insulation resistance as low as 1,000 ohms and as high as 200 megohms may be measured.

MEL The unit of pitch. A pure tone of 1,000 c/s of intensity equivalent to 40 dB above the threshold of hearing is equal to 1,000 mels.

METRES Unit of length in the metric system—39.37 in. In radio transmissions, the wavelengths are stated in metres, and their relationship to frequency is listed under Wavelength.

METRONOME An instrument for fixing tempi in music. The clockwork type commonly used is attributed to Maelzel (1772–1838) and has a bell that can be set to strike every second, third or fourth beat.

Metronome marks indicate the number of beats to a minute, but should only be used as a very flexible guide to the speed at which the music should be played. (Even composers change their minds here.)

MICRO One millionth. One microvolt equals one millionth of a volt.

MICROGROOVE Known also as a long-playing record, a microgroove disc is cut with 200 to 300 grooves per inch, and the normal turntable speeds are $33\frac{1}{3}$ and 45 rpm.

Microgroove records at $33\frac{1}{3}$ rpm were first issued in this country by Decca in 1950. The radius at the bottom of the groove was 0.5 mil and the correct stylus point had a 1 mil radius, with the result shown in Fig. M/1.



FIG. M/1.

Original microgroove with correct size of stylus.

With the advent of stereo, groove radius has by design—if not always in practice—been reduced to 0.25 mil so that a half-mil stylus can be used successfully, or 0.7 mil as a compromise.

Mono grooves have also been reduced in radius so that a stereo pickup can be used without bottoming, which often occurs if the fine point is used on older microgroove discs.

One benefit of using fine grooves and points is the improved performance from the inner grooves where the surface speed is slow and the wavelengths to be traced are correspondingly shorter. With a 12" record at 78 rpm the cutting speed starts at 47"/sec and falls to 17"/sec, but at $33\frac{1}{3}$ rpm the speeds are 20"/sec down to 9"/sec, where the wavelength at 10 kc/s is just less than 0.001". It is clear that under these conditions a half-mil point will give better HF performance with less tracing distortion at the inner grooves than a 1 mil point, but the playing weight must also be reduced to avoid excessive groove damage.

MICRON A unit of lineal measurement. One micron equals one millionth of a metre or one thousandth of a millimetre. 25 microns=1 mil.

MICROPHONE A microphone is a device for converting sound energy into equivalent electrical impulses, which means that acoustical principles are of equal importance to electrical ones, and are, in fact, often more difficult to apply successfully.

Most microphones have a circular pickup pattern as shown at A in Fig. M/2, except the ribbon which has a figure-of-eight characteristic as at C. Other field patterns such as semi-directional and cardioid can be arranged by combining different types and by methods of use.

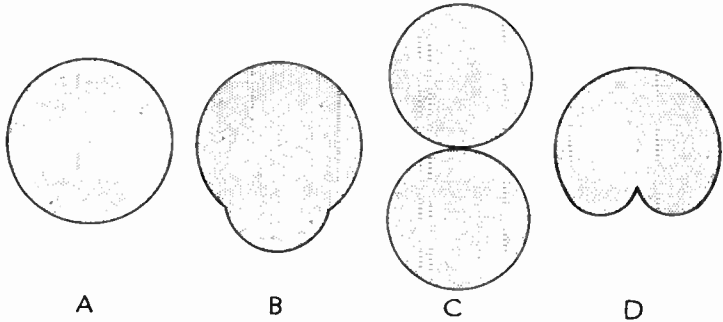

FIG. M/2.
Basic field patterns of microphones.

A—Omnidirectional;
B—Semi-directional;
C—Figure-of-eight;
D—Cardioid.

Many types are available, ranging from the humble carbon granule mic. used in telephones to expensive capacitor models used in recording and broadcasting studios.

A brief description of each type now follows. All are pressure-operated with the exception of the free ribbon, which responds to the particle velocity of sound waves.

Carbon Granule. Vibrations of the diaphragm produce changes in pressure on carbon granules packed into a small cavity. The resistance through the granules varies in sympathy with the sound waves and modulates a small direct current passing through the microphone.

Although carbon microphones produce a very high output signal they suffer from restricted, peaky response, high distortion and high noise level, but can be made at a low price. The main output range suits speech better than music.

Moving Coil. The moving coil or dynamic microphone has been widely used, often in a spherical shape to provide a uniform pickup pattern.

With low impedance voice coil windings there are no line troubles from capacitance effects, and a wide frequency response with good sensitivity can be achieved.

Moving coil microphones are also robust and stand up well to difficult climatic conditions.

Ribbon. This type employs a ribbon of corrugated aluminium foil freely suspended in a magnetic field. The better designs are capable of very wide frequency range, low distortion and excellent transient response due to high electromagnetic damping.

The ribbon is fragile and easily disturbed by shock or blasts of air so that it cannot be used out of doors except under suitable weather conditions.

The impedance and the output are low. A transformer, specially designed, is required and is usually built into the microphone case.

When a velocity microphone is placed very close to the sound source the lower frequencies are emphasised, resulting in boomy speech.

Crystal. The majority of inexpensive microphones are crystal types employing a Rochelle Salt generating element coupled to a diaphragm of thin metal or paper. The frequency range is rather limited and irregular, but results are usually satisfactory on speech. The sensitivity is very high.

The better crystal microphones employ directly actuated sound cells which have lower sensitivity but much wider and smoother frequency response.

All crystal microphones are high impedance devices requiring very high input impedances to avoid loss of bass. The capacitance of long connecting leads will result in a loss of signal voltage without upsetting tonal balance. Screened leads up to about 50 ft. are satisfactory.

Microphones based on Rochelle Salt are affected by high humidity and by temperatures above about 130°F.

Ceramic types using a barium titanate slab or the new lead zirconate elements have similar characteristics to Rochelle Salt microphones but are less affected by high temperatures and humidity.

Capacitor. Also known as condenser or electrostatic, this type of microphone is widely employed for high quality professional work because of its uniform, wide frequency response and low distortion. The construction consists essentially of a stretched diaphragm situated close to a rigid metal back plate with polarising voltage between them. Highly developed models employ a double diaphragm arrangement and by varying the polarising voltages it is possible to achieve a wide variety of pickup characteristics, including omni-directional, figure-of-eight and cardioid.

Owing to the high impedance, the first amplifying stage must be mounted in the microphone case and as near as possible to the diaphragm.

Special Types. Among the many excellent designs available today, for studio and film work as well as for frequency measurements, two special types of microphone are worthy of mention.

One is the Western Electric Cardioid, which is a combination of a ribbon and a moving coil diaphragm. When the outputs from the two elements are mixed in the correct proportion and phase a cardioid characteristic is obtained. The individual elements can also be used to give figure-of-eight or omni-directional patterns at the touch of a switch.

The other interesting design is the Electro-Voice Model 642 which has a sharply directional pickup pattern useful in TV or film work for selecting distant sound sources in noisy surroundings or unfavourable acoustic conditions. See Fig. M/3.



FIG. M/3.

Electro-Voice highly directional dynamic mic. The sound is picked up through openings in the narrow shaft.

Matching. As with pickups, it is important that the load conditions applied to a microphone should be considered, otherwise response and output will be affected.

MIL One thousandth of an inch. A convenient form of reference to stylus radius. It is much easier to say half-mil than 0.0005".

MILLI One thousandth; thus one milliamperere is one thousandth of an ampere, but Millicent is a girl's name.

MIMING Having noticed a few obvious instances of miming on some of the lighter television musical programmes, I wrote to the B.B.C. to ask for any available information on the subject, and Mr. M. G. Foster sent on the following memorandum which seems to cover the situation pretty adequately:

"First of all, the use of miming in light entertainment programmes is rigidly controlled, and good reasons have to be

advanced before it is permitted. Broadly speaking, miming takes two forms.

“Firstly, when an artist mimes to his or her own commercial record. This happens when we wish to capitalise on a successful record in which the voice and/or the musical accompaniment uses acoustic or electronic tricks which are extremely difficult, or indeed impossible, for us to duplicate under normal studio conditions. In these cases we sometimes, therefore, present the artist visually but use the ‘gimmick’ of the record by having the artist mime.

“The second reason is in order to achieve camera flexibility. In many big production scenes, particularly those which involve a large number of artists, it is frequently impossible to achieve up-to-standard sound coverage and, at the same time, get the pictorial flexibility which the scene demands. In these cases the sound track is sometimes pre-recorded to overcome this problem.”

MIXER (a) An electronic circuit capable of combining two or more separate signals into a common output. A microphone channel mixer will combine the signals from several microphones into a single blended programme, or on stereo a centre microphone can be suitably apportioned to the left and right-hand channels.

(b) A type of valve used in superheterodyne receivers which combines the incoming RF signals with the output from a local oscillator.

MODULATION The process by which information is impressed on a carrier wave by varying its amplitude, frequency or phase.

Also in recording on tape or disc. A loud passage results in heavy modulation.

MOLECULAR ELECTRONIC AMPLIFIER An ultra-compact electronic device developed by Westinghouse in the U.S.A. The tiny audio amplifier occupies about 0.001 cubic inch and has a response from zero frequency to 20 kc/s with an output of 5 watts when fixed to a metal plate to dissipate the heat.

The amplifier (in black case) is seen on the right in Fig. M/4. The smaller device on the left is the molecular electronic preamplifier.

Inventions such as this and the General Electric Compactron could revolutionise amplifier design during the next ten years.



FIG. M/4. *Westinghouse Molecular Electronic preamplifier A and main amplifier B.*

MONAURAL Listening with one ear instead of two. This has nothing to do with single channel recording which is known as monophonic or monodic, and is conveniently abbreviated to mono, just as stereophonic is abbreviated to stereo.

MOTOR-BOATING A popping sound caused by positive feedback at low frequencies; a form of instability which used to be very common in amplifiers. A few years ago, the use of long leads or high capacitance values in crossover networks would set up motor-boating in some amplifiers, but all good specimens remain stable today despite the worst efforts of the loudspeaker maker.

MOVING ARMATURE A design of gramophone pickup in which the flux from a permanent magnet is varied by a pivoted soft iron armature attached to the stylus. The output signal is derived from coils wound around the magnet poles.

Another name for this type of pickup is variable reluctance.

MOVING COIL This well-known system is used mainly in loudspeakers, and in some microphones and pickups. The coil is suspended in a strong magnetic field and the application of a signal in the case of the loudspeaker causes the coil to move forwards and backwards, or vice versa according to phase, the attached diaphragm or cone also moving in sympathy.

In a microphone, the proceedings are reversed. Sound waves cause the diaphragm to vibrate, and the moving coil produces an ac voltage in sympathy.

The sequence of moving coil invention seems to have run as follows:

1877. Ernst Wermer patent filed by Siemens on December 14th of that year.

1898. Oliver Lodge patent, filed April 27th in that year.

1925. First working model produced by Rice & Kellogg in America and offered for sale in 1926.

1926. Tractrix horn patented by another pioneer in the MC field—P. G. A. H. Voigt. Although Mr. Voigt had been working on the moving coil principle since 1923, he was preceded at the patent office by Rice & Kellogg by a few weeks. His twin-cone device was also patented and is in fact still being used in various makes of full range loudspeakers.

MOVING IRON The predecessor of the balanced armature, the moving iron was the successor of the earphone-cum-horn type of loudspeaker. Its performance was non-linear due to unsatisfactory basic design.

MULTICELLULAR HORN Often used for treble output in cinema speakers, with 6, 8 or even 12 separate horns, coupled to a common throat, to ensure wide distribution of sound with maximum efficiency. Directional effects are put to good use.

MULTI-PATH DISTORTION A type of distortion produced by VHF receivers and tuners due to signals arriving at the aerial via several different paths, having been reflected from nearby hills or large buildings. The sound closely resembles harmonic distortion or an out-of-centre loudspeaker. The cure is to find a better position for the aerial or fit a more directional type to avoid the offending reflections.

MULTIPLEX A method of transmitting two channel stereo on a single FM carrier. This means that only one transmitter is required for the two signals, which are separated by a special adapter in the receiver and reproduced through two amplifiers and loudspeakers.

The problem is not that this can't be done, but that there are too many ways of doing it, and it may take a year or two for the various authorities (such as the B.B.C., F.C.C., N.S.R.C., C.C.I.R. and the E.B.U.) to agree on the best system to adopt.

It is also important to remember that any multiplex stereo transmissions should give acceptable results on ordinary single channel receivers, which will outnumber stereo sets for many long years to come, if not permanently. In nearly all the proposed systems, the so-called "compatible" mono programme is derived by the addition of the left and right-hand channels. If this debases the mono results, complaints will be fast and furious, and rather numerous.

MU-METAL Made by T.C.C. Also Permalloy by Western Electric; Hypersil by Westinghouse.

These, and similar products, consist of an alloy of nickel, copper and chromium having high permeability and low hysteresis loss in relatively low magnetising fields. They are widely used for screening low level transformers and recording heads and pickups from stray hum fields.

The material is also used as a core in high-grade pickup and microphone transformers. Since mu-metal cannot support high flux densities it is essential to avoid testing such transformers for continuity by means of an ordinary ohmmeter because the dc in the windings would permanently magnetise the core material.

MUTUAL INDUCTANCE When two coils are coupled magnetically so that flux lines produced by current in one link with the turns of the other they are said to be inductively coupled. The effects of this coupling are called mutual inductance.

To minimise such coupling, e.g. in crossover networks, coils should be orientated at right angles to each other or spaced well apart.

MUTUAL RADIATION IMPEDANCE When two diaphragms are placed close together so that sound radiated by one affects the other, they are acoustically coupled and mutual radiation impedance exists between them.

If two loudspeakers are mounted as shown in Fig. M/5 and connected in phase, an increase in output of nearly 3 dB is obtained at low frequencies.

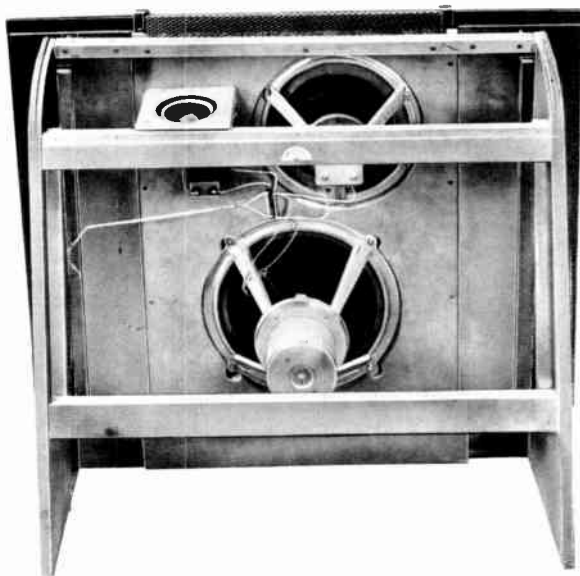

FIG. M/5. *Two loudspeakers, 12" and 10", in parallel for improved LF output due to mutual radiation impedance.*

N

N.A.R.T.B. National Association of Radio and Television Broadcasters (U.S.A.). A term applied to disc and tape recording and reproducing characteristics approved by this Association.

N.B.C. National Broadcasting Company, Inc. (U.S.A.).

N.D.R. Norddeutscher Rundfunk, Hamburg.

N.S.R.C. National Stereophonic Radio Committee (U.S.A.),
11 West 42nd Street, New York, N.Y.

Body set up to investigate problems associated with stereophonic broadcasting in the U.S.A. Appears to be largely composed of commercial firms.

N.T.S.C. National Television Systems Committee (U.S.A.).

NEGATIVE FEEDBACK When NFB is applied to an amplifier, a proportion of the output is fed back to the input in the reverse phase. This is done at the expense of amplifier gain, but properly done, the following benefits accrue:

- (a) Improved linearity, i.e. reduced harmonic and inter-modulation distortion.
- (b) More uniform frequency response characteristic.
- (c) Reduction in hum and noise level.
- (d) Reduction of internal impedance with consequent improvement in loudspeaker damping.
- (e) Reduction of phase shift.
- (f) Greatly reduced risk of distortion from incorrect load matching with loudspeaker.

Voltage feedback is the type referred to and is the one normally used, but current feedback can also be applied to raise the internal resistance and reduce the damping factor. This would improve the LF output from small speaker systems which depend on a fairly strong bass resonance for balanced performance. As a rule, however, the benefits of a damping factor of about 10 outweigh the drawbacks, and a touch of bass lift can easily be applied.

Some shortage of bass may also be noticed with a speaker fitted with a very powerful magnet and run with a high damping factor from amplifier, unless the unit is mounted in an enclosure of adequate volume or fitted to a large horn. In brief, as enclosure volume is reduced, damping may also have to be reduced to maintain good LF output. It is obviously better to retain the benefits of good magnetic and electrical damping and use larger enclosures whenever possible.

Attempts have been made to apply NFB to loudspeakers by adding a reversed winding to the voice coil, but the field is not a very promising one because many of the faults to which loudspeakers are prone just are not reflected into the voice coil at all, and the main resonances can be fairly well controlled by the damping already referred to.

NODE A point on a stationary wave system where the amplitude of vibration is at a minimum. The point of maximum vibration is an antinode.

NOISE Random sounds made up of many different frequencies which are not harmonically related as in musical sounds.

Noise effects are not a satisfactory means of judging quality of reproduction because distortion is not easily noticed. Many early demonstrations of disc stereo were given with more noise recordings than music and tended to build up the reputation of cheap reproducers to a level they hardly deserved.

Noise level is the value of noise expressed in decibels with respect to a specified level, usually 0.0002 dyne/sq.cm.

Some average noise levels are given in the following table. Any background noise above about 50 dB impairs the intelligibility of speech and mars the enjoyment of listening to music.

AVERAGE NOISE LEVELS

Very quiet room or recording studio	30 dB
Average living room	35 dB
Busy office	50 dB
Restaurant	60 dB
Average factory	75 dB
Weaving shed	90 dB
Full orchestra	120 dB

NON-LINEAR Anything which is not straight, out of shape or distorted is non-linear. In audio, we might almost say that non-linearity produces distortion and vice versa, without always specifying whether the hen or the egg came first.

Two oscillograms will serve to illustrate the phenomenon. In Fig. N/1 non-linearity in cone suspension movement distorts the wave form on a 40 c/s test, whereas in Fig. N/2 distortion produced in an amplifier removes the linearity of the test signals.

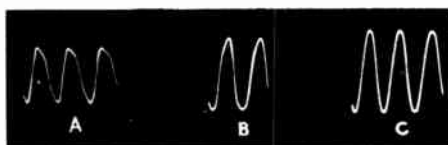

FIG. N/1. *Non-linearity at A and B at 40 c/s with 1 watt input to 10" unit.*
A—Corrugated paper surround.
B—Cloth surround.
C—Foam plastic surround.

Under Roll Surround, details of recent developments in avoiding non-linearity in bass speakers are outlined.

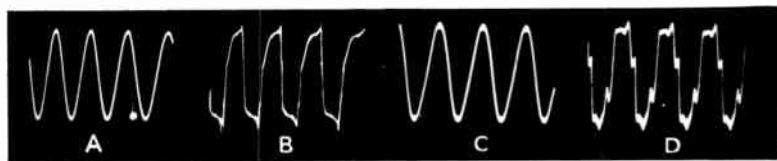

FIG. N/2. *Distortion caused by injudicious use of bass and treble lift in high-class amplifier.*
A—15 watts output at 40 c/s. Tone controls level.
B—Same as A but with maximum bass lift.
C—15 watts output at 10 kc/s. Tone controls level.
D—Same as C but with maximum treble lift.



OCTAVE The eight notes in the tempered scale in music, or the interval between two notes when the frequency of one is double that of the other. In addition to the lettered notes in the octave, we have also the five sharps or flats which are a semitone above or below the next note.

The interesting thing about the octave in the equally tempered scale is that each note is slightly out of tune, but one's ears are accustomed to the slight discordance. If you start to tune a piano at bottom C and go up in perfect fifths you eventually arrive at top C but you are a quarter of a semitone sharp; the frequency would be about 4,246 c/s instead of 4,186 c/s. It is this margin which the tuner has to get rid of by dividing each octave into twelve equal parts, instead of tuning in perfect fifths and other accurate intervals.

The error of about $1\frac{1}{4}$ per cent in pitch is known as the *Comma of Pythagoras*. (He must have had a good ear.)

OERSTED The unit of magnetising force or field strength in the cgs system. It is named after the Danish physicist Hans Christian Oersted, 1777-1851.

In common parlance we refer to the flux density of a magnet as so many lines per sq.cm. and this is still the most descriptive label to put on gap field strength, but the correct title is oersteds, Symbol H.

The word gauss is often used, Symbol B, but this is the unit of flux density in magnetic materials as distinct from air.

OFFSET ANGLE In recording, the cutterhead travels in a radial line across the disc, but pickups are usually mounted on an arm and cross the record on an arc. There will be considerable distortion in the reproduction if the resultant tracking error is not kept down to a minimum. The error can be reduced to very small proportions by off-setting the pickup head and by mounting the arm so that the needle overhangs the centre of the turntable by the correct amount.

When mounting a pickup and tone arm, the maker's instructions should always be carefully carried out.

OHM The practical unit of electrical resistance named after the German physicist Georg Simon Ohm, 1787-1854.

An electric circuit has a resistance of one ohm if an applied pressure of one volt causes one ampere of current to flow.

Ohm's law: $E = R \times I$.

ORGAN-ELECTRONIC The first pipeless organ—as it was called—was invented in 1930 by two Frenchmen, Messrs. Coupleux and Givelet, the wind and pipes being replaced by radiophone lamps, amplifiers and loudspeakers. An American inventor, Captain Richard Ranger, demonstrated his first electronic organ in New York in 1931.

Since then, many thousands of electronic organs have been built, and great progress has been made in the reproduction of starting transients and harmonics to simulate the real thing.

No doubt organists and experts still prefer the acoustic to the electronic instrument, but the much lower cost and smaller size of the latter are often controlling influences.

Given adequate loudspeakers, remarkably good pedal notes can be reproduced. A very fine effort by J. Wood & Sons Ltd., Huddersfield, is illustrated in Figs. O/1 and O/2. The speaker cabinet measures 8 ft. × 4 ft. × 2 ft. and weighs no less than 13 cwt. (1,456 lb.), including the seven units. The complete model, with the decorative front made to resemble a pipe organ, weighs 1 ton.

Bass is produced by four 15" foam surround units mounted in a couple of reflex enclosures which can be "tuned" by the sliding panels seen in the photograph. Treble is taken care of by three 8" foam surround units, the crossover frequency being 800 c/s.

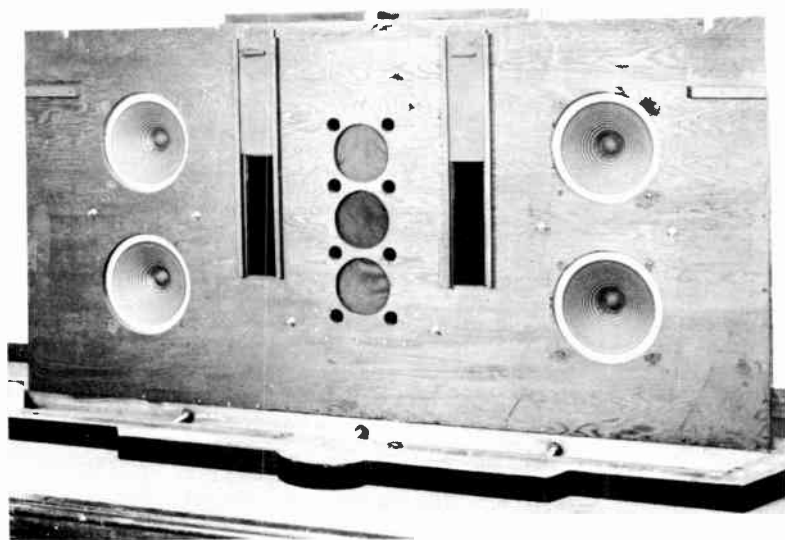

FIG. O/1. Loudspeaker system for electronic organ.

Courtesy J. Wood & Sons Ltd., Huddersfield.

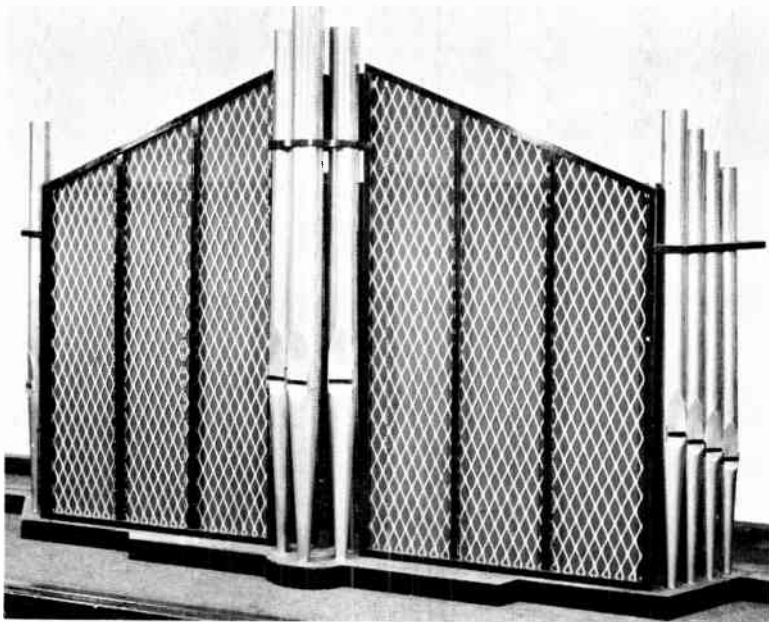

FIG. O/2. *Decorative front for system O/1.*

This equipment, coupled with a two-manual *Hurlitzer* organ, is being installed in All Saints Church, Silkstone, Barnsley, Yorks., at a total cost of about £1,700.

OSCILLATION In audio and radio, this usually relates to spurious parasitic oscillation due to faulty operation, which may occur at supersonic frequencies in amplifiers, causing damage and distortion.

Mechanical oscillation occurs in a microphonic valve due to loose elements or lack of internal rigidity. Such a valve, when tapped or vibrated, may produce a ringing sound or a continuous howl.

OSCILLATOR An instrument which generates a pure sine wave, often covering the frequency range of 10 to 40,000 c/s, and used for measuring the frequency characteristics of audio devices, as well as for tracing faults such as frequency doubling, formation of sub-harmonics, resonances and many others. A most important application is in checking harmonic distortion in amplifiers, but for this purpose the oscillator must produce a pure sine wave with less harmonic distortion than is present in any amplifier to be tested. Room resonances and standing wave effects can also be explored by microphone and examined and photographed on an oscilloscope.

There are, of course, many other uses for these instruments, such as routine checking of pickups, loudspeakers, etc., which are too numerous to mention.

A typical laboratory model, costing close on £700, and fitted with recording stylus for taking immediate response curves, is illustrated in Fig. O/3.



FIG. O/3.

Brüel and Kjaer audio oscillator, producing pure tone and warble tone as required.

There are two main systems used for generating the AF signals; one is the beat-frequency oscillator (BFO) and the other is the resistance capacity oscillator or Wien Bridge type.

The BFO is most generally used, because the whole audio range can be covered in one sweep of the dial, whereas the resistance tuned models are divided into three or four frequency ranges which have to be switched in and out.

The operation of the BFO is rather interesting as it uses difference tones or beats from two radio frequency oscillators, one of which is variable. Thus a fixed oscillator at 120 kc/s with a variable oscillator covering 100 kc/s to 120 kc/s will produce beats in the audio range up to 20 kc/s.

A warble tone is sometimes used to avoid the formation of standing waves in a room or enclosure used during the test. The frequency may be warbled through 20–200 c/s up to 32 times per second.

The advantages of the resistance tuned oscillator are that no warming up period is necessary before use and the frequency response is uniform. With a BFO, some minutes must elapse before it is fit for use, and drifting tends to occur, so checking and re-calibration to mains frequency or 100 c/s tuned reed is required from time to time during use, but this takes only a few seconds.

OUTPUT IMPEDANCE The output impedance of an amplifier is established by the ratio of the output transformer and determines the load required in the loudspeaker. (See Matching.)

The internal impedance of the amplifier may be very much lower due to negative feedback, which provides a useful damping factor with constant volts at the loudspeaker rather than constant current.

OVERLOADING This is more likely to occur in main amplifiers and loudspeakers than in earlier links in the audio chain because of the enormous increase in power which has to be dealt with.

Overloading is nearly always accompanied by severe audible distortion. In the case of amplifiers, the amount of distortion produced by a given percentage overload will depend upon the overload characteristic. With some designs, particularly those employing large amounts of negative feedback, harmonic distortion increases sharply beyond a certain power output as shown in Fig. O/4A. This type of characteristic produces distressing results with the slightest tendency to overstep the rated power output. On the other hand, amplifiers having smooth overload characteristics, whereby the onset of distortion is relatively gentle as at B in Fig. O/4, will handle moderate momentary overloads with only a trace of tonal roughness.

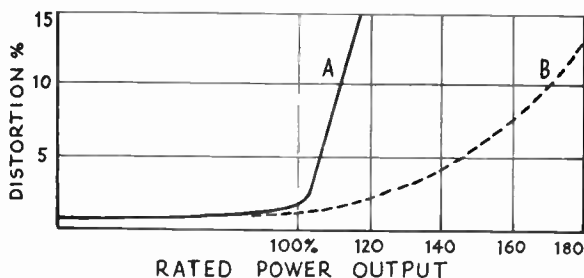

FIG. O/4. Amplifiers with different overload characteristics.

Overloading a loudspeaker can cause equally distressing results because frequency doubling is increased and all resonances are intensified, even if actual rattling is not heard. Fortunately, this form of overloading is not very prevalent today because 5 watts peak is ample for normal domestic listening and a decent 8" loudspeaker will handle such input without audible protest.

It is not suggested that amplifiers are worse than loudspeakers. There is little or no risk of overloading a modern high-class amplifier at home. Only yesterday evening I was listening to a Promenade

Concert on a compact 3-speaker system fed by a good commercial FM receiver with only 3 to 4 watts output. There was ample volume in a room 20 ft. by 14 ft. and the quality was superb—thanks to the excellent results the B.B.C. now produce from the quondam acoustically despised Royal Albert Hall.

OVERTONE This is another name for a harmonic of a fundamental frequency, the only difference being that the first overtone is the second harmonic. Thus 100 c/s is the second harmonic of 50 c/s but it is the first overtone; 150 c/s is third harmonic and second overtone; and so on.

P

PANEL RESONANCE If a panel is set into vibration, say by sound waves at a suitable frequency, it will tend to resonate according to its size, thickness, density and general structure. In musical instruments, resonance adds colour and warmth to the sound; in loudspeakers it should be avoided like the plague, especially with enclosures where high sound pressures are built up.

Reducing panel resonance gives better transient response and cleaner sound, with improved LF output because absorption of energy is avoided.

Some of the materials and conditions which help in the good cause can be listed as follows:

1. Small area;
2. Thick panels and rigid assembly;
3. High density;
4. Sand filling;
5. Gluing together two panels such as plywood and building board;
6. Coating with automobile under-sealing compound;
7. Dowelling;
8. Cross-bracing;
9. Lining with floor or bathroom tiles;
10. Expanded polystyrene. (Density only 0.02 gm/cc.)

Let us deal quite briefly with these various approaches to clean reproduction.

1. Unfortunately, small panels mean small cabinets and reduced bass, but panel resonance recedes accordingly.

2 and 3. In other words, increased weight. A full list of densities is given under D.

4. The first sand-filled panel seen by the writer was in a large baffle used by the B.B.C. at their Research Station at Balham in 1937. The absorbent qualities of sand have not changed in the meantime.

5. Celotex or building board pinned and glued to plywood is quite effective and the cost is low.

6. Although messy to apply, these materials have a good damping effect.

7. Dowels securely fixed between opposite panels cut down resonance with little addition to weight.

8. Cross-bracing is done with battens, say $1\frac{1}{2}'' \times \frac{3}{4}''$, glued and screwed on edgewise every 10 to 16 inches.

9. Loading panels with ceramic tiles firmly stuck in position works very well. See Fig. P/1.

10. An inch-thick panel of expanded polystyrene, held between thin plywood outside and hardboard inside, reduces resonance by extreme lightness and varied density, combined with very good rigidity.

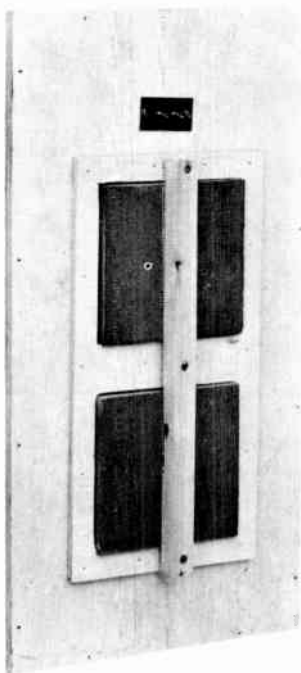

FIG. P/1.

Tiles firmly glued and battened to back panel $25'' \times 13''$ to reduce resonance.

Spreading Resonance Frequencies. Another way to mitigate trouble is to use panels of different size and cabinets of irregular shape. For instance, a column $14'' \times 12''$ is better than one $13'' \times 13''$.

Absorbents. Lining with absorbent material such as fibreglass, felt, etc., is no good as an antidote to panel resonance.

Room Resonance. The absorbing effects of resonant panels are employed usefully in reducing the reverberation time of concert halls and sound studios at low frequencies, and may also be used to reduce domestic room resonance.

PARALLEL. When conductors or components are connected in parallel the total current in the circuit is divided between them.

RESISTORS

FIG. P/2.

Resistors in parallel.

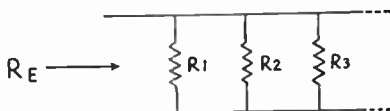

The effective value of resistors in parallel is given by:

$$\frac{1}{R_E} = \frac{1}{R_1} + \frac{1}{R_2} + \frac{1}{R_3} \dots \text{etc.}$$

If the values are 12, 6 and 3 ohms respectively, the answer works out as follows:

$$\begin{aligned} \frac{1}{R_E} &= \frac{1}{12} + \frac{1}{6} + \frac{1}{3} \\ \frac{1}{R_E} &= \frac{2 + 4 + 8}{24} = \frac{14}{24} \\ \therefore R_E &= \frac{24}{14} = 1.7 \text{ ohms.} \end{aligned}$$

(Calculated by the Technical Editor.)

CAPACITORS

The effective value of capacitors in parallel is their arithmetic sum:

$$C_E = C_1 + C_2 + C_3 \dots$$

FIG. P/3.

Capacitors in parallel.

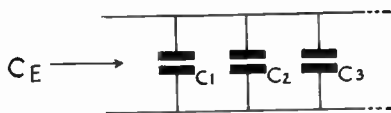

With values of 12, 6 and 3 Mfd the answer is 21 Mfd. (I worked this one out myself. G.A.B.)

INDUCTORS

In so far as arithmetic is concerned, inductors behave like resistors, which means that to increase the value they are connected in series.

Loudspeakers. It is usually better to run them in parallel than in series, because the impedance curve is flattened, resonances tend to be cancelled out, and if one speaker breaks down, the other(s) still work(s). Two 15 ohm units in parallel look like $7\frac{1}{2}$ ohms to the amplifier and share the honours evenly, but if you use a 3 ohm speaker with a 15 ohm model, the load looks like $2\frac{1}{2}$ ohms and the low impedance unit will absorb over 80% of the power. (Connected in series, the load becomes 18 ohms and the 15 ohm fellow does most of the work.)

PARASTAT A machine for cleaning records and coating them with a fine anti-static film, invented by C. E. Watts of Sunbury-on-Thames. Once treated, dust is easily removed and the discs remain static-free for a long time.

Pressings in an anti-static material, instead of polyvinyl chloride, have been produced, but it is not yet established that they are equal to the standard LP record in every respect. And as Percy Wilson points out in *The Gramophone*, the need to pick up the dust that falls on to the record through the air will still remain.

PARTIAL Although no longer in general use, this word has a similar meaning to harmonic and overtone. The fundamental is known as the partial, and the overtones are upper partials. There is actually a difference between harmonics, which are always multiples of the fundamental, and partials or overtones which *may* refer to frequencies outside the harmonic series. For example, the tuning fork and the bell produce many random frequencies which are upper partials or overtones but are *not* harmonics.

As a rule, scientists and engineers refer to harmonics, and musicians use the term overtones, neither group being partial to the partial.

Sub-harmonics would be called lower partials.

PEAK The maximum value of fluctuating voltage, current, sound pressure, etc.

In half a sine wave, the peak value equals 1.414 times rms value, or 1.57 times average value, as indicated in Fig. P/4.

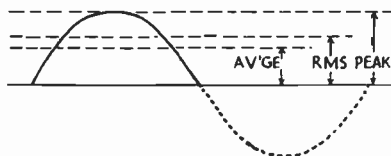

FIG. P/4.

Peak, rms and average values in a sine wave.

An amplifier rated at 10 watts rms in this country would be rated 20 watts peak in America.

PEAK PROGRAMME METER (PPM) An indicating meter together with an associated amplifier specially designed for measuring peak signals in broadcasting or recording equipment. The meter has a rapid rise time of about 2.5 milliseconds with a slow decay rate of about 1 second.

PPMs are used to ensure that the programme signal does not rise beyond a safe limit. Meters of this type are also fitted to high-class tape recorders.

(See also VU Meter.)

PERMEABILITY (Symbol μ or μ_r) This is a measure of the ease with which magnetic materials will support lines of force. High permeability materials are used as a core in high grade transformers and for shielding purposes. (See Mu-metal.)

After annealing, many of these materials cannot be cut, bent, dropped or heated without losing some of their quality.

In magnetic circuits, permeability determines the flux density produced by a given magnetising force, and is analogous to conductivity in electrical circuits.

PHASE The particular stage in a recurring sequence of movements or changes. Sound waves cancel out when completely out of phase, but add together when exactly in phase, with various in-between stages.

PHASE ANGLE The angle between current and voltage vectors in an electrical circuit. In a purely resistive circuit, phase angle is zero. A positive angle of 90° indicates pure inductance whilst a negative angle of 90° indicates pure capacitance. Intermediate angles suggest combinations of resistance and reactance, and are constantly cropping up in loudspeakers. The subject was well covered by our Technical Editor in the 5th Edition of *Loudspeakers*.

PHASE DISTORTION Phase distortion occurs when components of a complex electrical signal are subjected to different delay times according to frequencies as they pass through a recording, broadcasting or reproducing chain.

The human ear does not appear to be sensitive to minor phase distortions produced by normal domestic equipment, but gross delays of certain sections of the audio range such as those occurring in long transmission lines can produce annoying effects, particularly on speech and transient sounds.

According to H. M. Tremaine, phase shift is unimportant unless it is great enough to produce a time delay of more than 8 milliseconds at high frequencies and more than 15 ms at frequencies below 100 c/s.

PHON This is a unit of measurement of loudness which allows for the difference in sensitivity of the ear at different frequencies; but even the phon does not agree with the ear's idea of loudness, and there is no recognised scale based on this. When you reduce intensity level by half, or 3 dB, the impression in the ear is that it has only been reduced by about one-fifth.

The following table shows the difference of intensity required to maintain the same loudness to the ear as the frequency is lowered:

<i>Frequency c/s</i>	<i>Phons above threshold</i>	<i>Intensity in dB</i>	<i>Phons above threshold</i>	<i>Intensity in dB</i>
1,000	20	= 20	40	= 40
500	20	= 25	40	= 42
200	20	= 39	40	= 52
100	20	= 50	40	= 62
50	20	= 63	40	= 72
30	20	= 73	40	= 80

A similar effect occurs as the frequency goes up above 2,000 c/s, although to a smaller extent. There is a slight loss between 2,000 and 8,000 c/s, with a continuous drop above that range.

PHONOGRAPH American equivalent of gramophone. The original cylinder phonograph was invented by Edison who coined the term, and it is nice of our American cousins to remain loyal to their distinguished compatriot.

PIANO CHART The frequency (c/s) of the white notes in the tempered scale with A at 440 c/s and several wavelengths are given in Fig. P/5, along with indications of baffle size for specified response.

PICKUPS The electric pickup began to supersede the mechanical soundbox in 1924, since when designs have appeared in greater variety than in any other audio component.

With the complications of 45/45 stereo, the subject has become so vast that it is impossible to cover it fully in a reference book without disturbing the nature, size and cost of the publication, so we will content ourselves with a few general comments which may be of some help or interest to amateurs.

There are four main groups of pickups: (1) Crystal or ceramic; (2) Magnetic; (3) Dynamic or moving coil, which is also magnetic; (4) Variable capacitance or electrostatic.

A first-class model should have the following attributes:

1. Wide frequency response;
2. No undamped resonances;
3. Low harmonic distortion;
4. Light playing weight;
5. Reasonably high output;
6. Good signal to hum ratio;

	f	W.L.	D
TOP C	4186	3.25"	
B	3950		
A	3520	3.85"	
G	3138		
F	2794		
E	2636	5.15"	
D	2348		
C	2093		
B	1975		
A	1760	7.7"	
G	1568		
F	1397		
E	1318		
D	1174	11.5"	
C	1046		
B	987		
A	880	15.4"	
G	784		
F	698		
E	659		
D	587		
C	523	2'	1'
B	494		
A	440	2.5'	1.25'
G	392		
F	349		
E	330	3.5'	1.75'
D	294		
MIDDLE C	261		
B	247		
A	220	5'	2.5'
G	194		
F	174		
E	165	7'	3.5'
D	147		
C	130		
B	123		
A	110	10'	5'
G	98		
F	87		
E	82	14'	7'
D	73		
C	65.4		
B	61.7		
A	55	20'	10'
G	49		
F	43.6		
E	41	28'	14'
D	36.7		
BOTTOM C	32.7	35'	17'
B	30.8		
A	27.5	40'	20'

FIG. P/5.
Piano chart.

f = Frequency in cycles per second.

WL = Wavelength of sound (approx.).

D = Minimum diameter of baffle for speaker to reproduce down to frequency involved, with baffle suspended in free air.

Approximate length of Open Organ Pipes.

Frequency 16 32 64 128 256 c/s

Open Pipe 32 ft. 16 ft. 8 ft. 4 ft. 2 ft. long.

The length of a pipe closed at one end is half the above for the same frequency.

7. Adequate mechanical robustness;
8. Long term stability of performance;
9. Immunity to climatic conditions.

For stereo we must add:

10. Good separation between channels;
11. Well balanced output from each side.

As practically all modern pickups are stereo types, the last two qualifications make it difficult to place them in order of merit, because some adjudicators would sacrifice a little on other counts in order to have good separation, and vice versa.

A salient feature of good design is low moving mass giving negligible mechanical impedance at the stylus tip. This ensures accurate tracing with low playing weight and minimum wear of both stylus and record. Other important points include adequate damping of moving parts to avoid resonances and freedom from distortion under actual playing conditions.

The importance of the tone arm cannot be over-emphasised, but any pickup-tone arm combination which will track and trace loud stereo passages without trouble or distortion at 3 to 4 grms or less must be pretty good.

Now for a brief look at the four groups, without being too critical of any one, because great progress has been made in design and construction during the last 2 to 3 years.

Crystal or Ceramic. Owing to low cost and high output (both in volts and quantity produced) these are the most important from the commercial point of view. They can be used with very little correction beyond a load of not less than 1 megohm to avoid loss of bass, but a full control circuit is given in Fig. P/6.

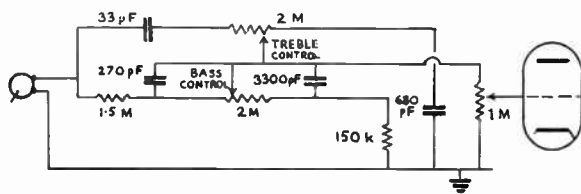

Courtesy Mullard.

FIG. P/6. Input circuit for crystal or ceramic pickup, giving bass and treble boost and cut with overall volume control.

The treble control may prove useful in getting rid of possible HF resonance in the pickup.

Some very good stereo models are being produced, but a playing weight of about 5 grms is usually necessary. As prices are often

much lower than for other types, some adjustments to load conditions along the lines of Fig. P/5 should help those who cannot afford (or do not wish to buy) an expensive model, to obtain optimum results.

At 5 to 6 grms, the use of a .7 mil point would reduce wear, but HF response and tracing at inner grooves would not be quite so good as with the fine .5 mil stylus.

Voltage output may go as high as several volts with mono types or 150 mV per channel with the more refined stereo models.

Magnetic. This group includes balanced armature, variable reluctance, moving magnet, and sum and difference types.

The internal impedance is usually less than 5,000 ohms, and the required external load is then 47,000 to 100,000 ohms, but the maker's instructions would normally be followed. Reducing the value of this resistance load may be useful for cutting down possible 12 kc/s resonance which occurs in some stereo magnetic types.

Voltage output is of the order of 10 to 120 mV at full modulation.

Moving Coil. The operation of this type is essentially linear. As with other magnetic pickups, the design and construction of good moving coil stereo models call for fine tolerances and delicate handiwork. The wire used in the coils may be only half-thou. thick.

Moving coils are a low impedance device and require a matching transformer of possibly 200 to 1 ratio to bring the output voltage up to the level of other magnetic types. Only high-class transformers, well shielded from hum, should be used.

Ribbon. This is basically a type of moving coil with a single turn. Although capable of first-class results, the ribbon pickup has not been a success commercially.

Other Types. In theory, electrostatic and frequency modulated pickups should give excellent results because mechanical moving parts are to some extent replaced by electronics, but no stereo versions are available in this country at present.

As most pickup designers and makers appear to have a one-track mind in favour of two-track operation, there would appear to be no point in pursuing the topic any further.

Fine Work. The following photograph shows an operation in the assembly of the Decca pickup and gives some idea of the delicate work involved.

Stereo pickups are inherently more complicated and delicate than equivalent mono instruments.



FIG. P/7. *Mounting armature in Decca pickup head.
Note fine connecting leads on right.*

Voltage Output. As this is lower with stereo pickups than with similar mono types, the signal to noise ratio is worse in some directions, such as rumble, hum in pickup leads and in preamp, so greater care is necessary. Turning up the volume also increases these noises.

PICOFARAD One billionth of a farad. (In more civilised countries such as America and France it is one trillionth.) Symbol pF, which is 10^{-12} F in any country.

PIEZO-ELECTRIC Certain substances possess the property of generating electrical voltages between opposite faces of specially cut pieces when subjected to mechanical deformation. The process also takes place in reverse.

These characteristics have been made use of in the design of microphones, pickups, recording heads and even loudspeakers.

This phenomenon is called piezo-electricity and substances which exhibit the effect include Rochelle Salt (sodium potassium tartrate), ammonium dihydrogen phosphate, lithium sulphate, quartz and barium titanate. The latter is one of a group of piezo-electric substances known as ceramics.

PINCH EFFECT In lateral disc recording, the groove is cut by a chisel with a flat face which is only at right angles to the groove direction in the unmodulated state or at the crest of a wave. This results in a groove of varying width, which pushes a round reproducing stylus up and down in the groove, and is known as pinch effect.

It is essential to provide for a measure of vertical compliance in a pickup in order to avoid serious wear due to this effect but it is equally important that no signal shall be produced by vertical motion of the stylus, otherwise second harmonic distortion will appear in the output from mono records.

This also explains why the vertical output from a stereo pickup must be cancelled or shorted out when used on mono records. Wiring instructions for achieving this are provided by the manufacturers.

PINK NOISE A sound consisting of random noise components covering the full audio range in which sound energy per octave is constant. Pink noise is derived from white noise by applying a rising bass characteristic through the range.

When used for comparing speakers, it has a much warmer tone than white noise, just as a pink gin has a warmer taste than plain white gin.

PITCH Standard pitch in Europe and America is now A 440 c/s. The B.B.C. Third Programme is preceded every day by a tuning note which is exactly 440 c/s, the degree of accuracy being something phenomenal. The short-term stability is, in fact, ± 1 part in 100 million, and the long-term stability is $\pm 2\frac{1}{2}$ parts in 100 million.

This signal provides an easy way of checking the pitch of a piano, and if recorded on a tape recorder can be used for checking its speed constancy by comparing with note A on the piano at any later date.

Another method of checking pitch and tape speed is to use mains hum and compare it with bottom G on the piano, which is 49 c/s, and G sharp at 52 c/s.

The simplest way to check pitch is obviously the tuning fork which costs about 8s. today. Concert pitch models are easily available from piano dealers.

The human ear tends to assess pitch slightly higher than true frequency in the bass and the opposite way at high frequencies. For this reason, musical instruments are preferably tuned by ear once the concert pitch note has been determined, rather than by scientific methods, although the Conn Chromatic Stroboscope has been produced in America and can be used for tuning by visual means. Known as the Stroboconn, this is a frequency measurer working to great accuracy over a range of seven octaves.

The pitch of musical instruments is also affected by temperature, particularly the oboe, which is therefore used by an orchestra to provide the tuning note, unless a piano concerto is to be played, when the pitch must be taken from the piano.

Many concert pianists prefer to have the piano tuned just a shade sharp in the top octaves as this seems to brighten the tone, and probably makes the short strings blend better with the overtones of the long strings which tend to be slightly sharp. In some orchestras, the violins are also tuned slightly sharp to give a more brilliant tonal effect.

All of which goes to show that pitch is more of an art than a science, and explains why the tone of a piano varies according to the skill and ear of the tuner.

PLASTIC FOAM Various plastic materials are now available in expanded or cellular form and some are very useful in audio devices.

The most important are polyurethane isocyanate and polyether, which are soft sponge-like, flexible materials. They are available in various densities, textures and colours and are widely used as surround materials for loudspeaker cone termination. They remain unaffected by normal climatic conditions, apart from a darkening of colour when exposed to light.

In a few countries where abnormally high humidity and temperatures prevail, the ordinary plastic foam begins to disintegrate after about 18 months, but special grades for tropical use have been developed and so far seem to stand up to the most exacting conditions.

Expanded polystyrene and polyvinyl chloride in rigid panels are useful in the construction of loudspeaker cabinets, to reduce panel resonance and weight, as mentioned earlier in this section of the book.

PLAYING WEIGHT The downward force exerted by the pickup stylus on the record groove. Equivalent terms are stylus force and tracking weight. References to pressure are not really correct because this varies with the area of contact.

The playing weight should be adjusted to the *minimum* required to trace a heavily modulated groove, in order to reduce record and stylus wear also to a minimum. All good tone arms are nowadays fitted with adjustable controls and some are calibrated in grms. Suitable weighing machines for checking the weight can be bought at a low price and often prove to be a good investment. One is illustrated in Fig. P/8.

Playing weight varies enormously with type of pickup, tone arm design and conditions of use. Unlike most things, such as motor cars, refrigerators, cabinets, carpets, etc., where the heaviest usually

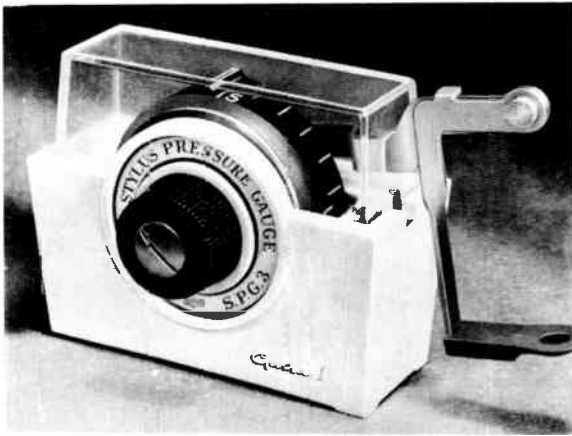

FIG. P/8. Garrard instrument for checking playing weight.

cost the most money, the pickups and tone arms which play at the lightest weight are the best and certainly the most expensive.

Since the advent of stereo discs with vertical modulation, much research has gone into pickup design to achieve good vertical as well as lateral compliance, and tone arms have also been revolutionised. Models which will play satisfactorily at 2 grms are now appearing and this means the virtual disappearance of record and stylus wear (with diamond points).

When adjusting playing weight it is nevertheless advisable to use 1 gm too much rather than 1 gm too little, because distortion results if full contact with groove is not maintained.

To avoid undue wear on record and stylus, half mil points should be used with a maximum playing weight of about $3\frac{1}{2}$ grms; 0.7 mil at $4\frac{1}{2}$ to 5 grms, and 1 mil points at a maximum of 6 grms. (Mono pickups are normally fitted with 1 mil points, but as they usually have lower vertical compliance they should not be used on stereo discs.)

Pickups fitted to automatic record changers have much higher playing weights to operate the mechanism. For instance, our Technical Editor bought a cheap record player for his children only last week, and found the playing weight was 12 grms. One playing of a collection of classical records on the machine would damage the lot!

POLAR DIAGRAM The polar diagram or directivity pattern of a speaker is a pictorial presentation of its response as a function of angle at a specified frequency.

The pick up pattern of a microphone can be represented in a similar manner.

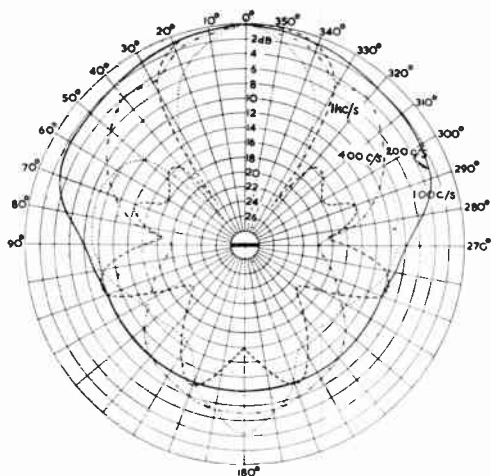

FIG. P/8A. Polar diagram of line source loudspeaker at 100, 200, 400 and 1,000 c/s.

POLARITY This indicates which terminal in electrical apparatus is positive and which is negative, or in magnetic bodies which pole is north and which is south.

In a loudspeaker, the polarity determines whether the voice coil moves forward or backward when connected, say, to the positive terminal of a battery. The polarity of the speaker depends on the direction of the voice coil winding and on the direction (N or S) in which the magnet has been magnetised.

When used singly, the polarity of loudspeakers does not matter at all, but when used in parallel or for stereo, the polarity affects phasing and is extremely important, although treatment is very simple and calls for nothing more than reversing one pair of leads.

PORT An opening or vent in a bass reflex cabinet through which low frequencies are radiated. The port may be a simple aperture in one panel, or it may be elongated in the form of a pipe to improve results with very small enclosures by avoiding a tiny opening.

The relationship between port area, enclosure volume and vent resonance frequency is given in the following table. It is usually satisfactory to aim at a 40 cycles resonance. The larger the enclosure, the less critical are the standards. In fact, above about 15 cu.ft. port or no port makes little difference to the enjoyment of the meal.

TABLE OF PORT AREAS IN SQUARE INCHES

Cabinet Volume cubic feet	Vent Resonance Frequency — c/s				
	30	35	40	45	50
2	—	—	3	4	6 sq.in.
3	—	4	6	8	11 sq.in.
4	4	6	9	13	18 sq.in.
5	5	8	13	20	26 sq.in.
6	7	11	17	25	36 sq.in.
7	8	15	22	33	48 sq.in.
8	10	17	27	41	61 sq.in.
9	13	20	34	51	76 sq.in.
12	20	34	56	88	130 sq.in.

For pipes, or for walls more than one inch thick, areas may be calculated from the following formula:

$$f_v^2 = \frac{2700 A}{V (L + 0.96\sqrt{A})}$$

where:

f_v = enclosure resonance frequency.

A = area of vent or pipe in square inches.

V = volume of cabinet in cubic feet.

L = thickness of cabinet wall, or
length of pipe, in inches.

POSITIVE FEEDBACK In an amplifier, if a proportion of the output is fed back to an earlier stage in such a way that the overall gain is increased, the feedback is said to be positive.

If positive feedback is excessive the circuit will become unstable and continuous oscillation will occur. An oscillator is in fact an amplifier with sufficient positive feedback to maintain instability.

Unwanted positive feedback often causes trouble in badly designed equipment by setting up spurious oscillation and instability.

A few amplifiers have been produced in which positive and negative feedback are combined to give negative internal resistance.

POTENTIOMETER A resistor fitted with an adjustable tapping point or slider. Originally developed as a method of measuring emf, it is now widely used as an infinitely variable volume control in audio circuits.

POWER The rate of doing work or the rate at which energy is converted or dissipated. The unit of electrical power is the watt.

PREAMPLIFIER A small voltage amplifier used with microphone, pickup, tuner, etc., and often including equalization circuits so that almost any main amplifier can be added. The noise level and distortion must be extremely low, and it is often an advantage to be able to place the preamplifier close to the source of input, with the main amplifier some distance away.

The modern preamp. for home use is quite a complicated piece of equipment. In addition to inputs for radio, mic., tape and disc, we have stereo and mono, and there should be provision for matching different types of pickup. Fortunately, only one play-back characteristic is now necessary; older records can be balanced by the tone controls, which are another *sine qua non*.

PRE-ECHO In disc recording a very loud signal can sometimes deform the wall of a closely adjacent groove so that it is possible to hear a faint reproduction of heavy modulation which occurs immediately after or before a quiet passage. These effects are known as pre- and post-echo.

PRE-EMPHASIS This relates to the boosting of high frequencies in recording or FM broadcasting to improve the signal to noise ratio when equivalent de-emphasis is applied during reproduction. This reduces surface noise on discs, tape hiss, etc. A typical characteristic is shown in Fig. P/9.

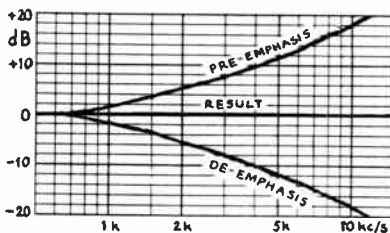

FIG. P/9.

Typical 75 microsecond
pre-emphasis curve.

PRESSURE Force per unit area, i.e. dynes per sq.cm. or pounds per sq.in.

Sound pressure levels are usually quoted in dB relative to a reference of 0.0002 dynes per square centimetre.

PRINT THROUGH When a magnetic tape recording is stored for long periods there is a tendency for heavily modulated signals to be "printed through" to adjacent layers producing an effect somewhat similar to pre-echo and increasing the level of background noise.

The effect is partly dependent on tape thickness but principally on the magnetic properties of the tape itself. Modern developments aim at minimising the trouble.

Storage at high temperature and the presence of stray magnetic fields are known to accelerate printing. Periodic respooling of valuable recordings may be advisable to prevent serious deterioration. This is routine practice with master tapes in the big recording companies.

PUBLIC ADDRESS Installations for addressing a large number of people are commonly known as PA systems. Metal horns have been mainly used for loudspeakers for durability and efficiency, but in railway stations the combination of metallic sound source with metallic structures and arches often produces acoustic chaos which is a standing joke to travellers looking for a seat on a train. The use of line source speakers mounted at a reasonable height in place of little tin trumpets 20-30 ft. aloft generally results in better intelligibility and more pleasing tone quality.

Q

Q (a) The magnification factor of a resonant circuit. For instance, a small reflex enclosure (Helmholtz resonator) has a sharply tuned resonance and a high Q , whereas a large one is very broadly tuned and the Q is low. A resonant circuit is critically damped when $Q=0.7$.

(b) The ratio of reactance to resistance in an inductor.

R

R.E.T.M.A. Radio — Electronics — Television — Manufacturers Association, 777 14th Street N.W., Washington 5, D.C., U.S.A.

RF Radio Frequency. Any frequency used for communication by means of electro-magnetic radiation.

R.I.A.A. Record Industry Association of America Inc. (U.S.A.), 1 East 57th Street, New York, N.Y.
A trade association similar to our B.R.E.M.A.

R.I.A.S. Rundfunk im American Sektor.

RMS The root mean square or effective value of a waveform is equal to the steady value which would give the same dissipation or heating effect in specified conditions. See Fig. P/3.

R.T.F. Radio-diffusion Télévision Française.

RADIATION The transmission of energy through space by a process which does not involve the circulation of energy-carrying particles, sound waves being a good example.

RADIATION IMPEDANCE The motion of a cone or diaphragm is opposed by its self-radiation impedance. It is also opposed or assisted by the radiation from any nearby diaphragms or reflected images to which it is coupled. The power radiated by a loudspeaker is therefore influenced by the presence of other units or reflections, especially at low frequencies.

The use of two loudspeakers in parallel to improve LF output has been referred to under Mutual Radiation Impedance, but the effects of wall and floor reflections are also considerable, and are neatly illustrated in Fig. R/1. One speaker at B, near the floor, radiates twice as much low frequency energy as one at A, but placed in the corner at C the LF output is again doubled. The reflecting surfaces are shown by shading.

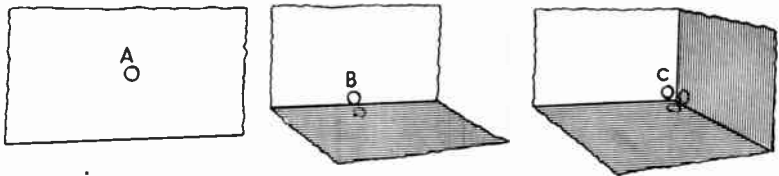

FIG. R/1. LF output increased at B and C by floor and wall reflections.

When mounting a loudspeaker in a tall cabinet, the difference to LF output between placing it near the floor and 18" higher is quite noticeable on programme, but whether or not you want the extra bass will depend on the size of the speaker and on the treble output, because the important thing is to achieve a good balance.

In a similar way, any cabinet speaker radiates more bass when placed near the floor or in a corner, but a lot of treble goes astray if radiated at ankle instead of ear level.

Large rooms also improve the radiation impedance at low frequencies and give better bass than small ones.

It is not often in this life that we get something for nothing, but with floor reflection at LF we do seem to succeed.

RADIO SETS It will be seen from Figs. R/2 and R/3 that the sales of radio sets are on the up grade in both Great Britain and America. The situation across the Atlantic was neatly summed up by the U.S. Correspondent of *The Financial Times*, issue 30th March, 1960, in the following words:

“Last year, in one of the most unexpected reversals of merchandising trends in a long while, the American radio set industry boomed. This was after it had been in eclipse for about a decade, following the advent of television in the later 1940s.”

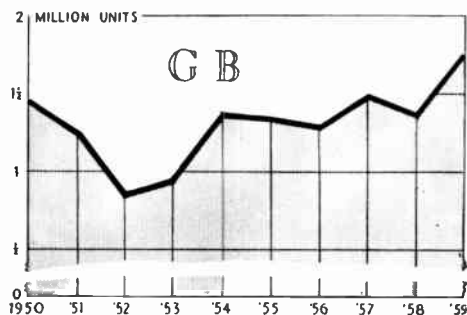

FIG. R/2.

Radio set sales in Great Britain during the last 10 years.

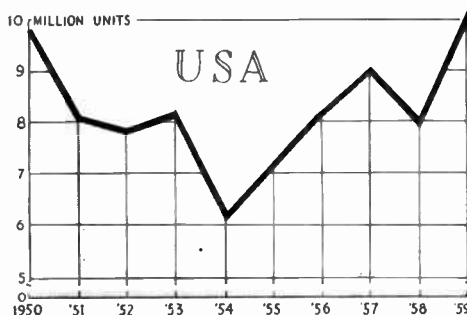

FIG. R/3.

Radio set sales in U.S.A. during the last 10 years.

During the first half of 1960, sales continue to expand, whereas TV sales show a sharp decline.

There are two main reasons for this trend.

The first is the tremendous boom in transistor sets, which are dealt with under T.

The second is the excellent quality now obtainable from the VHF-FM broadcasts, with wide frequency range due to VHF and quiet background due to FM. Many who enjoy music turn to this source of relaxation as a relief from incessant Westerns on TV.

It is a pleasure to report that all the steam has not yet gone out of steam radio.

As to the future, there has been a suggestion that commercial radio should be allowed to enter the sound field by opening about 100 local transmitters to provide music, news and trade announcements during daylight, but not after sunset due to interference problems. Personally, I think it is a rotten idea. The B.B.C. have served us well and should retain their monopoly in the sound field, with commercial jingles confined to I.T.V.

RADIOGRAMS As distinct from portable record players, which have met with a lively demand, the sales of radiograms have shown a downward trend during the last three years. According to figures published by B.R.E.M.A. dispatches from factories have been as follows:

<i>Number of Radiograms dispatched</i>	1957	1958	1959
...	266,000	218,000	187,000

This shows that the advent of stereo has not resulted in boom conditions in the radiogram industry, although makers will no doubt claim that stereo reduces boom in the quality of reproduction.

On the other hand, sales during the first half of 1960 show an upward trend of about 25 %.

Many radiograms now include VHF reception, and about 60 % in this country are equipped for stereo (compared with 100 % in America). It is inevitable that, if the same standards of reproduction are to be retained, a stereo model must cost 50 % to 75 % more than a mono version, and price has no doubt had its effect on sales. It would be extremely foolish to buy a second-rate stereo outfit in preference to a good single channel model.

Another difficulty with stereograms is the fact that flexibility in the location of a loudspeaker is often an advantage in obtaining optimum results with stereo in certain rooms, and this is impossible if the speakers are fixed in one cabinet.

RANDOM NOISE Noise comprising thermal agitation, valve and transformer or Barkhausen varieties.

Valve Noise (also called shot noise) is due to random fluctuations in anode current in a valve.

Thermal Agitation Noise arises from the random movement of electrons in a circuit. (See also Johnson noise.)

Barkhausen Noise arises in transformers operating at low level due to the fact that the core material is not magnetised smoothly but in a series of small steps or increments.

RAYLEIGH It is no exaggeration to describe John William Strutt, Third Baron Rayleigh (1842-1919) as the father of modern acoustics. A peer by inheritance, Lord Rayleigh devoted his life to scientific investigation and in 1877 published his researches in acoustics as two volumes entitled *The Theory of Sound*. This book remains a treasure-trove of erudition after more than eighty years; testimony to Rayleigh's penetrating mind.

REACTANCE The limiting effect of inductance or capacitance on the flow of alternating current. The unit is the ohm.

The values follow a simple rule. As the capacitance is doubled the reactance is halved; as the frequency is doubled the reactance is again halved. With inductance, exactly the reverse takes place.

The reactance/frequency values of components normally used in crossover networks are given in the following tables:

REACTANCE OF CAPACITORS

				at 50	500	1,000	5,000	10,000	c/s
24	Mfd	133	13	6.7	1.33	.667	ohms
12	Mfd	267	26	13	2.67	1.335	ohms
4	Mfd	800	80	40	8	4	ohms
1	Mfd	3,200	320	160	32	16	ohms
.5	Mfd	6,400	640	320	64	32	ohms
.25	Mfd	12,800	1,280	640	128	64	ohms
.1	Mfd	32,000	3,200	1,600	320	160	ohms

REACTANCE OF INDUCTORS

				at 50	500	1,000	5,000	10,000	c/s
0.5	mH157	1.57	3.14	15.7	31.4	ohms
1	mH314	3.14	6.28	31.4	62	ohms
2	mH628	6.28	12.56	62	125	ohms
3	mH942	9.42	18.84	94	188	ohms
4	mH	1.25	12.56	25.12	125	251	ohms
5	mH	1.57	15.7	31.4	157	314	ohms
0.1	H	31.4	314	628	3,140	6,280	ohms
0.5	H	157.0	1,570	3,140	15,700	31,400	ohms
1.0	H	314.0	3,140	6,280	31,400	62,800	ohms

RECORD PLAYERS The enormous interest in portable record players is revealed by the fact that in October, 1959, no less than 120 models, produced by 40 different firms, were available at prices ranging from £9 19s. 6d. to £52 16s. 8d. for mono types.

According to a summary in *Electrical and Radio Trading*, issue 31st October, 1959, the price grouping was as shown in Fig. R/4, the most popular models being in the £20 to £30 class.



FIG. R/4. Models available in October 1959, arranged in price groups.

Eleven models are battery-driven, with transistors giving $\frac{1}{4}$ or $\frac{1}{2}$ watt output. Most of the others are for ac, with a few ac/dc types.

The cheap machines work with one valve giving $\frac{2}{3}$ watts, usually into a 5" or 7" x 4" loudspeaker. The better sets use 2 or 3 valves and give 4 to 7 watts output, sometimes with more than one speaker or perhaps a single 10" x 6" elliptical.

For £43 you get 5 valves with 8 watts and a couple of 7" x 4" units.

According to the reviewer, there is a marked upswing of interest in the better quality instruments compared with the previous year.

Portable Stereo Players. Here the number of models available is 37 from 26 different sources, and prices range between £19 19s. (one only) and £47 5s., in the proportion shown in Fig. R/5.

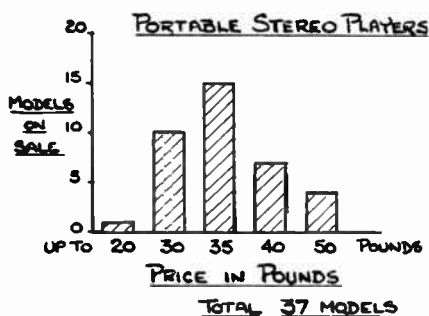

FIG. R/5. Models available in October 1959, arranged in price groups.

Most models use 2 valves only and give $1\frac{1}{3}$ watts per channel, but one at £40 19s. goes up to 2×5 watts, using 6 valves in all. Only two are transistorised and give $\frac{1}{4}$ watt to each speaker!

The speaker arrangements vary quite a lot and work out as follows:

Models	Loudspeakers
21	1 internal, 1 external
6	2 external
5	2 internal
3	2 detachable
1	1 internal, 2 external
1	Twin ,, Twin ,,

General Outlook. In spite of the fact that 47 portable models are available for stereo, it seems doubtful that the supremacy of the mono record in this market will be overcome. Many "pop" records contain so much artificial echo that they gain little from stereo, and if a good portable player is converted to two channel working without loss of quality the weight and size must go up, with considerable sacrifice of convenience and portability.

RECORDS AND RECORDING In writing about records here, we refer to the flat disc, as distinct from tape or any other type of record.

The phenomenal growth of the record industry in this country and the U.S.A. is shown in the following graphs, based on information obtained for us by the Special Services Department of *The Financial Times*. It is interesting to note that the value of sales of British records for home and export has gone up from £4,371,000 in 1949 to £17,066,000 in 1959.

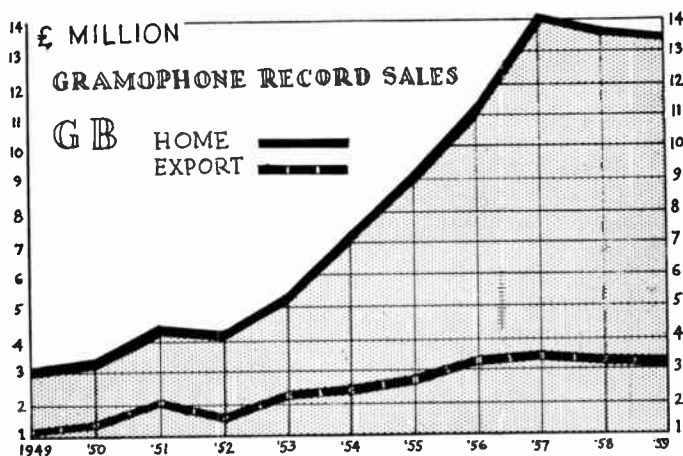

FIG. R/6. Annual sales value of records during ten years, home and export totals being shown separately.

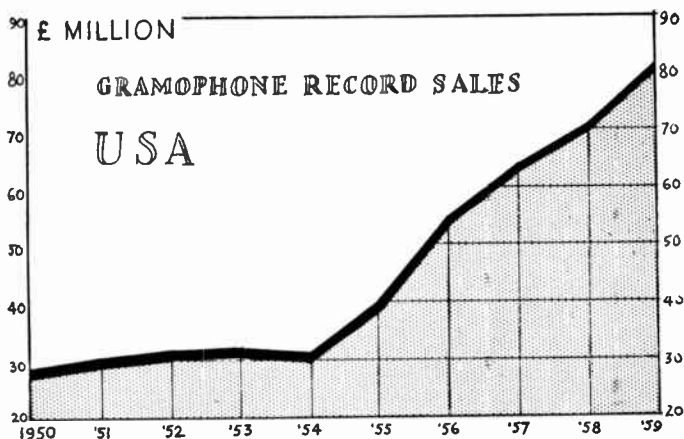
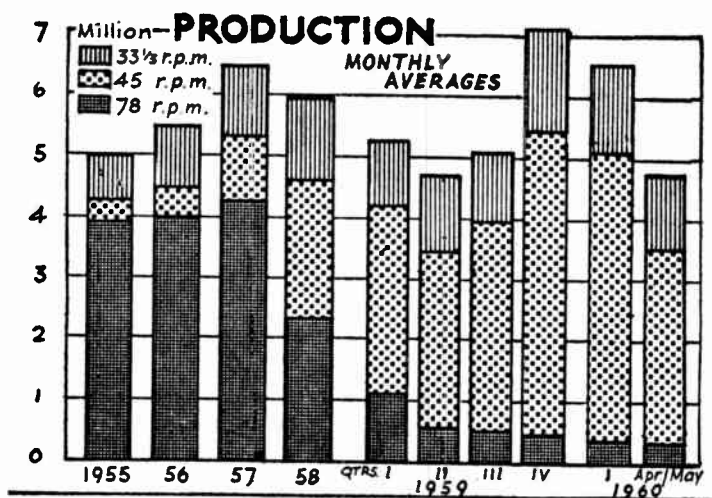

FIG. R/7. Total American sales during same period.

The peak year in Great Britain was 1957, in spite of the launching of disc stereo in 1958, but the early months of 1960 show a rise of about 25% compared with 1959.

78, 45 and 33½ rpm. It is interesting to note how sales are split up between the three types of record, and the position is compactly shown in the histogram of Fig. R/8. Since 1955, the production of 78 rpm has dropped from 4 million records a month to less than ½ million, being replaced mainly by 45 rpm.



Courtesy *The Financial Times*

FIG. R/8. Average monthly production of 78, 45 and 33½ records in Great Britain since 1955.

The sale of 33½ rpm's has remained fairly steady, and although greatly outnumbered by 45 rpm 7" records, the total playing time of the LP's is probably longer!

Turning to the U.S.A., a breakdown of records into speeds—based on manufacturers' shipments—produced the following figures:

RECORDS PRODUCED IN U.S.A.
(figures in millions)

Year	78 rpm	45 rpm	33½ rpm
1956	68 M	108 M	49 M
1957	Negligible	187 M	63 M
1958	"	111 M	83 M

Figures for 1959 were not yet available, but it can be assumed that 78 rpm's are no longer in production.

Mono v. Stereo. Practically all stereo records are $33\frac{1}{3}$ rpm, and it is estimated that about 20% of the classical long-playing records being sold today are stereo. For certain pieces of music, where the stereo is particularly effective and provides a good "demonstration piece" to convince doubting friends, sales can be as high as 50% for the stereo version.

RECORDING

In dealing with records and recording, we are fighting shy of technicalities, which cannot be adequately dealt with in an A to Z and are already covered in many existing articles and books. Instead, we are looking at aspects which are not normally covered, and this brings us to a few photographs kindly furnished by Decca, which show that recording and record making is a fine art.



FIG. R/9. *Engineer at work in Decca studios during recording session.*
Note large number of controls.



FIG. R/10. *Keen observation of process of cutting lacquer disc at Decca studios.
Note swarf extraction plant in right-hand background.*

The sequence of record processing is as follows:

1. Lacquer original—positive;
2. Metal master—negative;
3. Metal mother—positive;
4. Metal stamper, known as the working matrix—negative;
5. Pressing—positive.

The “master” is grown on to the original disc by several hours of copper plating. The “mother” is then produced from the master in a similar way, so that the master may be stored away and used at some future date in case of damage to the mother. The actual pressing is done by the working matrices, which can be produced from the mother as often as required. Where only a small number of pressings are wanted, they may be obtained direct from the master, thus eliminating two stages of the full sequence used for bulk production.

The Decca Record Co. kindly invited us to visit their factory at New Malden, Surrey, and take photographs of some of the most interesting operations, which are reproduced here. The skill shown is quite astonishing, but I understand they cannot yet recognise the music or the composer by simply looking at a metal positive, although Edmundo Ros’ maraccas tend to glisten in the grooves!



FIG. R/11. *Silvering the original lacquer disc.*

Fig. R/11 shows a recorded lacquer disc being silver "plated" by chemical precipitation to provide a metal conductive film suitable for nickel plating.

The nickel film is then plated with copper to enable the negative mould to be separated from the disc and used as a "master" plate for further reproduction, being No. 2 in the sequence.

In Fig. R/12 we see the production of nickel stampers, which are No. 4 in the sequence. In these vats a solid nickel film approximately .012" thick is being deposited by electrolysis on to the face of the positive plate.

The final operation is shown in Fig. R/13.

The pair of profiled nickel stampers are shown set up on dies fitted in a large power press. The dies have channels through which steam and cooling water are circulated at different parts of the complete press cycle.

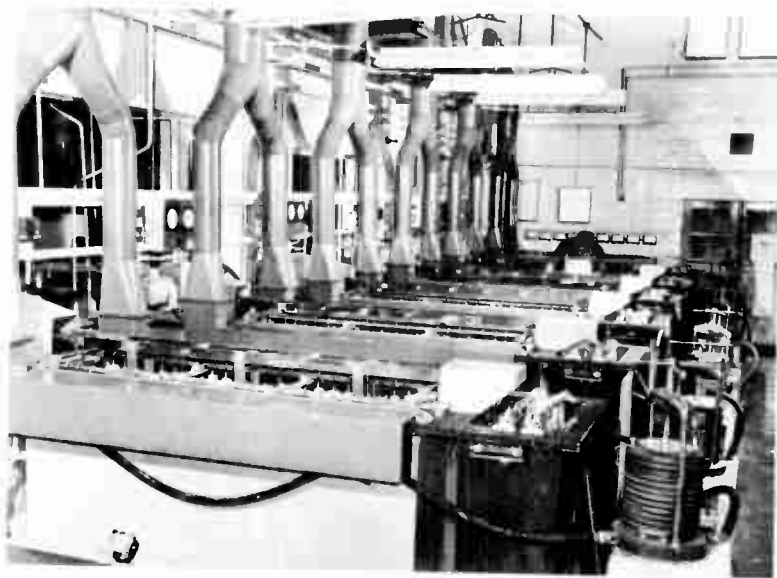

FIG. R/12. High speed nickel plating vats producing solid nickel stampers.



FIG. R/13. Pressing the final record.

Labels are placed on to centre pins of which the upper one is visible in the photograph. A charge of pre-heated diced material is placed on top of the label on the bottom die, as can also be seen from the photograph.

The next operation will be for the press to close and the charge of material be subjected to hydraulic pressure and heat, and finally cooled, due to the passage of water through the die channels.

The further of the two records to be seen on the operator's work-table, shows its condition as it leaves the record press. The nearer record has had excess material trimmed from its edge and has been placed upon a baseplate and spindle for transmission to the Examination and Packaging Departments.

All modern recordings are initially made on tape, usually at 15"/sec, and are then transferred to disc, using very fine equipment similar to that illustrated in Fig. R/14, which costs nearly £9,000 complete, ex works in Denmark, and provides for variable groove pitch and depth of cut.

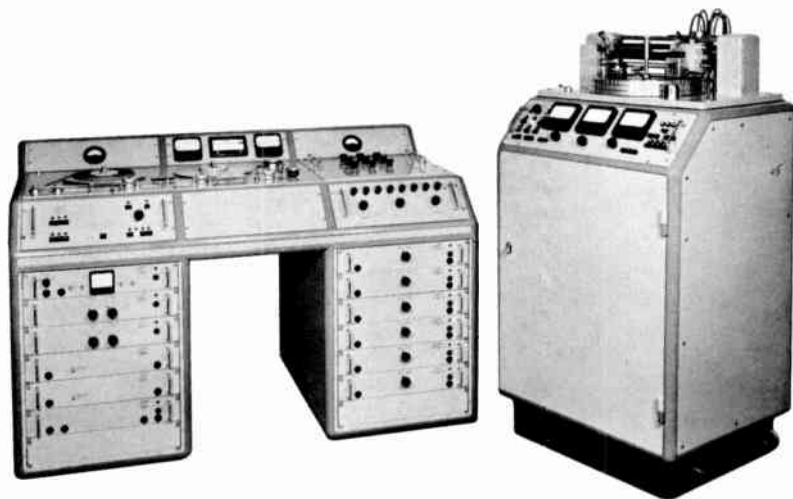

FIG. R/14. Stereo disc recording equipment by ORTOFON, Copenhagen.

The console includes a tape reproducer with $7\frac{1}{2}$ ", 15" and 30" speeds, and no less than eleven amplifiers for transcription of mono/stereo recordings to disc.

The disc recording machine runs at 78, 45, $33\frac{1}{3}$ or $16\frac{2}{3}$ rpm, and the stereo cutting head alone costs about £800. This will give the reader some idea of the precision required in modern recording technique.

RECORDING CHARACTERISTIC

A standard characteristic was adopted by the industry in 1953. The replay curve is reproduced in Fig. R/15, and this is of course the inverse of the recording characteristic.

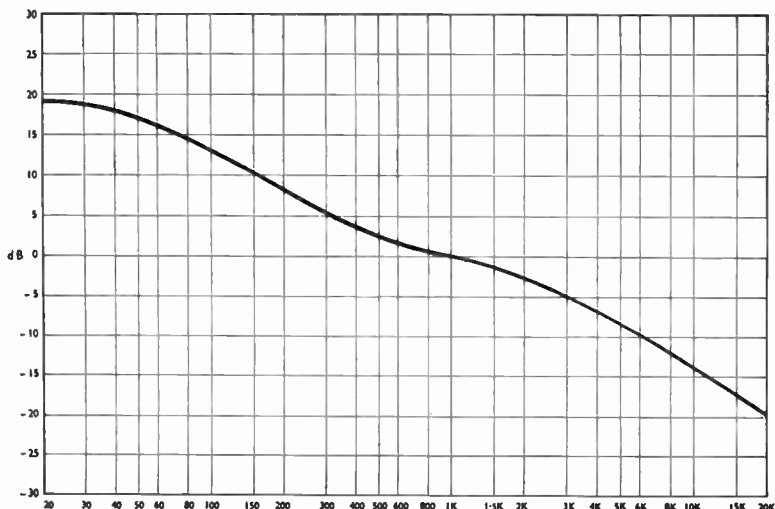

FIG. R/15. Standard replay characteristic for microgroove records in U.S.A. and Great Britain (R.I.A.A. and B.S.S. 1928/1955).

The characteristics for tape are given under letter T.

In recording, de-emphasis is used in the bass. It avoids excessive groove amplitude and increases playing time per record. Pre-emphasis in the treble improves signal to noise ratio.

RECORD WEAR Improvements in disc material and turntables and the production of stereo pickups and tone arms which will play satisfactorily at $3\frac{1}{2}$ grms or less have virtually eliminated excessive wear of record and stylus during normal use, even with half-mil points.

We tested the position very thoroughly at the Audio Fair in London in May, 1960, when we played one section of a $33\frac{1}{3}$ rpm stereo record 165 times to different audiences, using a Decca pickup at $3\frac{1}{2}$ grms, and there was very little audible distortion at the final demonstration.

We then sent this dance record to Dr. P. Chippindale and Dr. P. Lord of the Royal Technical College, Salford, who took photomicrographs which show two spots which have been played 165 times. It is interesting to note that the heavily modulated groove

shows the most wear, and also that a stereo record does actually contain different "information" on each side of a groove, although the left-hand side in the picture is not necessarily the left-hand channel in reproduction.

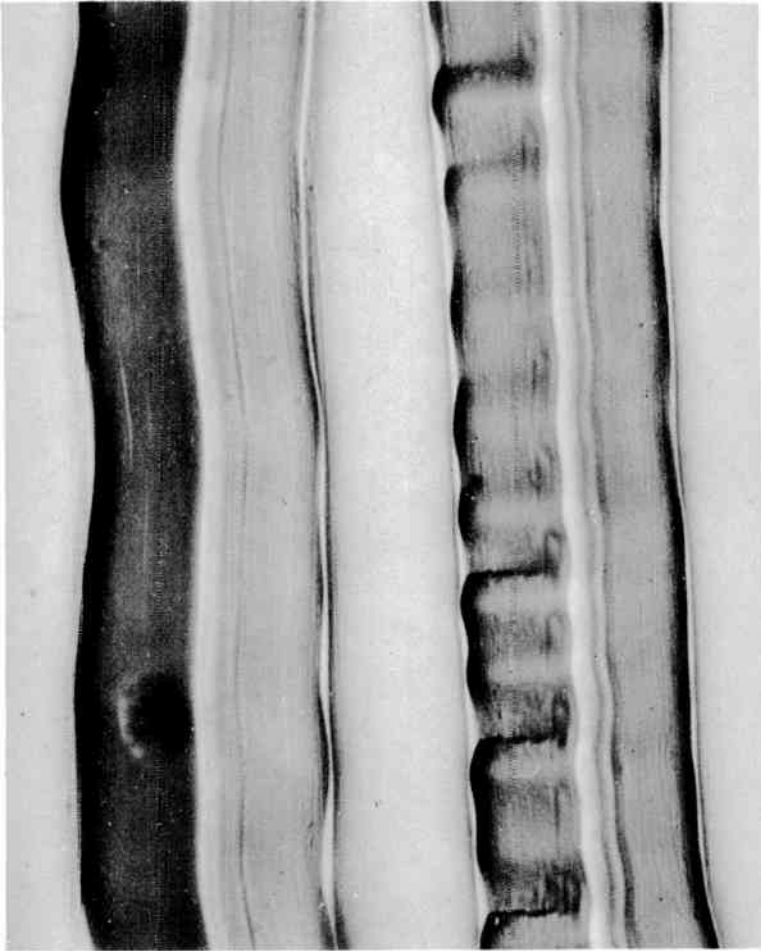

FIG. R/16. Groove after 165 playings showing little wear. Mag. 300x.

Photomicrographs by Dr. P. Chippindale

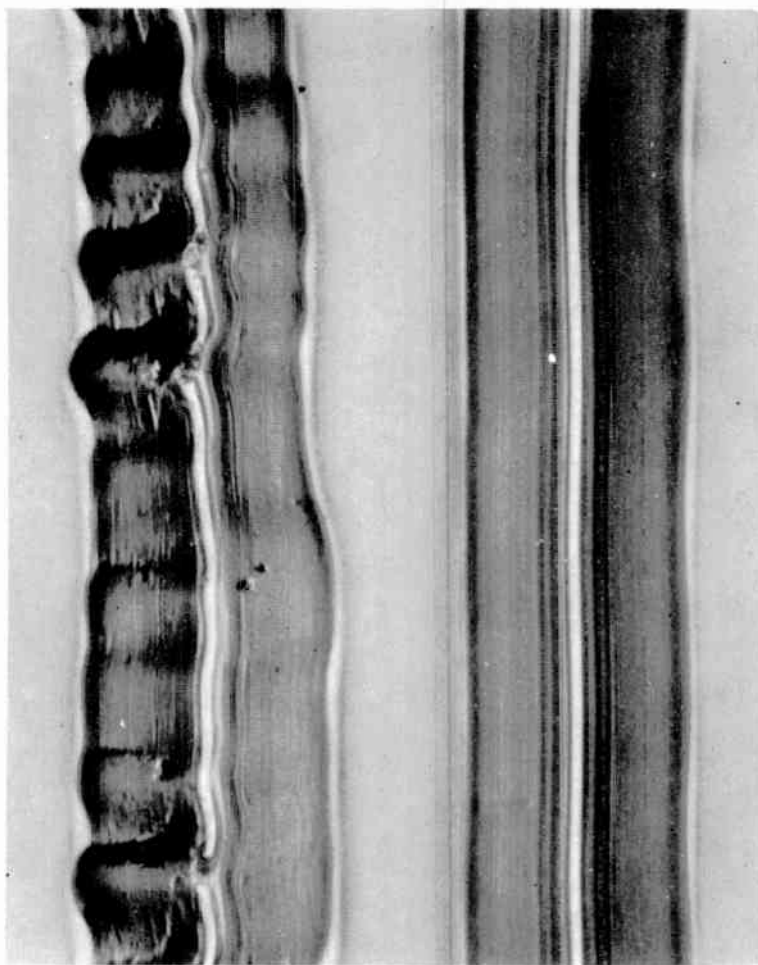

FIG. R/17. *Heavily modulated groove after 165 playings showing slight signs of damage. Mag. 300x.*

REFLEX CABINET A type of loudspeaker enclosure fitted with a vent or port through which out-of-phase radiation from the back of the cone is "reflexed" to bring it in phase with the front radiation at low frequencies.

RESISTANCE A property of electric circuits which causes electrical energy to be dissipated in the form of heat. The practical unit of resistance is the ohm.

A resistor is a device possessing a substantial proportion of resistance.

In audio equipment, e.g. transformer windings, coils in crossover networks, loudspeaker leads, etc., the resistance of the wire must be low relative to circuit impedance to avoid loss of power. In leads for electrical equipment, an adequate gauge of wire must be used to avoid setting the house on fire by dissipating too much heat.

RESISTANCE OF WIRE

		<i>Diameter</i>	<i>Copper</i> <i>ohms/100 ft.</i>	<i>Aluminium</i> <i>ohms/100 ft.</i>
18 swg	...	1/·048"	0·45	0·727
20 swg	...	1/·036"	0·80	1·288
24 swg	...	1/·022"	2·14	3·46
30 swg	...	1/·0124"	6·75	10·88
36 swg	...	1/·0076"	17·95	29·00
40 swg	...	1/·0048"	45·00	72·6
44 swg	...	1/·0032"	101·00	163·5
		<i>Flex</i>	<i>ohms/100 ft.</i>	
		23/·0076"	0·81	
		14/·0076"	1·32	
		3/·029"	0·47	

RESONANCE When certain bodies are vibrated, either mechanically or by sound waves, they resonate at a spot frequency or over a frequency range according to their constitution, size, shape, etc. The resonances may be of short duration, or may build up gradually to a peak, and die away slowly after the applied force has been removed.

A tuning fork is designed to resonate at a certain pitch and produce a recognisable note when struck, but the soundboard of a piano is expected to resonate to some extent throughout seven octaves, although it succeeds much better in the bass than in the treble.

In transducers, resonances colour the reproduction and may result in hangover, so the general idea is to push them outside the audio range or damp them. Unfortunately, the will to do so is often hampered by practical limitations.

RESPONSE CURVE When a response curve of a microphone, pickup or amplifier is accurately taken, the widest and smoothest curve will usually be obtained from the best instrument. With loudspeakers the situation is not quite so simple. The idea that a level axial response throughout the audio range gives the most natural reproduction is a fallacy. A characteristic rising smoothly in the upper registers is often required, depending on method of mounting and room conditions. Pronounced resonant peaks are objectionable, but axial response is usually quite different

from 30 or 60 degrees off axis, so directional effects cannot be ignored.

Finally, a normal response curve does not expose frequency doubling or hangover from cone or cabinet resonance, so the speaker curve should be looked upon as an indication of frequency range covered rather than as a final assessment of overall performance.

REVERBERATION The reverberation period of an enclosed space is the time taken for a sound to die away to one millionth of its original intensity, or -60dB .

Reverberation time varies with frequency, and depends on the cubic volume of the room or hall, and the absorption factors of walls, floor, ceiling and contents.

For domestic rooms, a reverberation time of less than one second is about right, but for concert halls something like 2 seconds evenly spread over the audio range is usually considered ideal, varying of course according to size.

A very short reverberation time gives dry, crisp sound effects with clear speech, but in theatres where absorption is mainly at high frequencies, music sounds dead and woolly.

Too much reverberation destroys clarity and definition but seems to suit organ music.

Studios. Control of conditions in studios is now a fine art. That it is no recent phenomenon is proved by the following quotation from *Modern Gramophones and Electrical Reproducers* by P. Wilson and G. W. Webb.

“The next development in the art of recording is to be looked for in the provision of special recording studios in which the recording conditions can be controlled. A good deal of research is at present (1929) being carried out on these lines.”

Artificial Reverberation. Any book on sound reproduction and acoustics will tell you how to get rid of excessive reverberation. The next few paragraphs tell how to produce extra reverberation if required.

Reference to echo chambers has already been made, but most recording companies now use electro-mechanical devices. Fig. R/18 illustrates one built in 1956 by our Technical Editor, Mr. Cooke, and is followed by a brief description of its origin and how it works. (It still works!)

Originally designed by Dr. Kuhl of Germany, and further developed by Mr. Lauridsen of Danish State Radio, the example shown was built in our own laboratory without much difficulty.

Basically, it consists of a metal plate driven at one point by an electro-mechanical vibrator which is fed with the programme signal. Transverse vibrations are set up in the sheet metal which suffer multiple reflection—in fact the plate behaves rather like a “thin” room having length and breadth but no height. Furthermore, because the velocity of sound in the metal is about 15 times

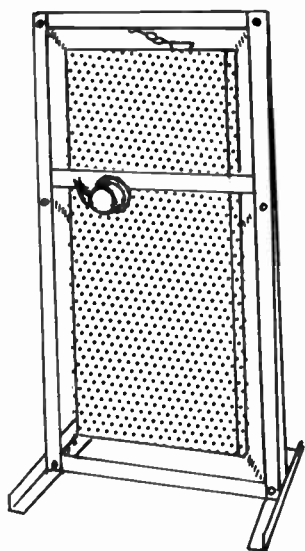

FIG. R/18.

Reverberation device designed by Dr. Kuhl. The driver is a normal 13,000 gauss loudspeaker magnet, fitted with voice coil in mechanical contact with perforated plate. Crystal pickup rests on top edge of plate, which is in expanded aluminium and measures 18" × 40".

that in air, a plate of modest dimensions will behave like a very large room. The reverberation signal is picked up at the edge of the plate by an amplitude sensitive device such as a crystal bimorph. Mr. Lauridsen has found that when the plate is in the same room as the loudspeakers there is a tendency towards acoustic feedback, so he produced a modified apparatus employing a perforated plate which is almost acoustically transparent, and this avoids the trouble from feedback.

By routing part of the output from the main amplifier via this artificial reverberator and feeding the output to a second amplifier-loudspeaker combination, very interesting effects can be obtained. The acoustics of the listening room are masked and the listener has the sensation of being in a large hall, thus adding "life" to the music. The bass and middle registers take on a roundness which is very pleasing, and edginess in the treble is considerably reduced.

Heard alone (via loudspeaker) the vibrations from the plate sound like harmonic distortion *in excelsis*, and added to speech the result is ridiculous, but the improvement to choral, orchestral and organ reproduction is acclaimed by all who have heard it.

Vibrating a sheet of metal with musical impulses and feeding the distorted output to an amplifier and speaker system is calculated to make writers about "perfect" loudspeakers go berserk. So we might as well end the reverberation section by asking once again: *What is distortion?* or *What is perfection?*

RIBBON A moving coil transducer made with a single turn of thin metallic foil is usually referred to as a ribbon device. The idea is that the ribbon actually works on the moving coil principle.

Ribbon Loudspeaker. This is usually made with thin corrugated aluminium about $\frac{1}{8}$ " wide and 2" long, suspended in a strong magnetic field, and operates as a moving coil speaker in which the voice coil and diaphragm are one and the same.

A transformer with very low impedance primary is required for matching normal amplifiers, and horn loading is necessary for efficient operation down to about 2 kc/s.

Good response up to 20 kc/s with excellent damping can be obtained, but the fragile ribbon is inclined to be vulnerable to mechanical and electrical shocks.

Ribbon Microphone. Here the construction resembles that of the loudspeaker, but with a smaller ribbon element which may be 1" long and $\frac{1}{4}$ " wide and less than 0.0001" thick. The risks of overloading and displacement are less than with a ribbon loudspeaker.

The ribbon is a velocity type microphone with a figure-of-eight pick-up pattern when used with open mounting back and front; the frequency and transient response are excellent.

Ribbon Pickup. Several models with first-class technical performance have appeared but none has stayed the course. Fragility and low output with a taste for hum were the main sources of trouble.

RIPPLE The small amount of ac remaining in the dc output of a rectifier power supply is known as the ripple content. The permissible ripple varies with the type of circuit being supplied, 15% being admissible with some types of power amplifier whilst 0.1% may be the limit to secure hum-free operation from a high-gain preamplifier.

Electrolytic capacitors are affected by ripple considerations because the presence of an inordinately high alternating current may cause overheating and eventual breakdown. The maximum permissible ripple current is usually marked on such capacitors.

ROLL OFF This relates to the frequency at which an equaliser or tone control circuit begins to operate, and also to the rate of attenuation, which may be 6 dB or more per octave.

The roll off frequency is usually taken as the point at which the response has been reduced by 3 dB.

ROLL SURROUND This is a development in cone suspension which has been brought about by the need for large cone excursions to produce good bass from small enclosures, say less than 2 cu.ft., which push up the frequency of cone and enclosure resonance compared with larger cabinets and, therefore, make it much more difficult to produce adequate cone movement in the 30 to 60 c/s region without non-linearity.

A brief glimpse at the "surround" field during the last thirty years is not without interest. Early moving coil speakers were fitted with leather or similar surrounds—hand assembled. Then came the one-piece moulded cone with corrugated surround which reduced costs enormously and established the moving coil speaker in all markets.

After the second world war the interest in high fidelity began to develop, and some speaker makers found that users were willing to pay 10s. extra for the lower resonance and smoother "top" obtained by reverting to hand-fitted soft surrounds, usually cloth.

Then came plastic foam, with better elastic properties than cloth, which permitted greater cone movement at low frequencies without stress or strain, and is still the best available suspension for a full range speaker with normal mounting. But with small tuned or total enclosures, the slight porosity of foam is a disadvantage and the air-tight roll surround comes into the picture.



FIG. R/19A. *Small plant devoted to the production of roll surrounds.*

Basically, the roll permits the maximum of movement without non-linearity for a given distance between edge of cone and chassis, and the fabric can be impregnated and moulded to shape and then treated with plastics to seal it and improve edge damping. Cone resonances below 25 c/s in 12" units are now a practical proposition.

Our own installation for this purpose is illustrated in Figs. R/19A and B. Forming and cutting out on left, followed by plastic treatment and drying by radiant heat are seen at A. The automatic press at B is pneumatically operated by pressing two buttons—one with each hand for safety—and releases itself after the requisite six seconds for moulding have transpired.



FIG. R/19B. *Pneumatically operated and timed moulding press.*

There can be little doubt that the excellent LF performance now possible with acoustically designed small enclosures has helped to establish stereo in rooms of moderate size. Such models are also useful for improving the results from tape recorders, TV sets and good VHF receivers, where the internal speaker has to work in a much more confined space.

ROOM ACOUSTICS The effect which loudspeakers, listening-rooms and recording equipment actually have on programme material can be demonstrated by re-recording and then re-playing an item in the same room through the same speaker. If you repeat the operation three or four times, you end up with a complete travesty of the original, because room and speaker resonances are built up to enormous peaks.

A similar change may take place if a book or article is translated into a foreign language and then translated back into English by somebody out of touch with the subject. In a recent Swedish experience of ours, a reference to record grooves came back as "pulley tracks" and a pious hope that our last book on Stereo had not bored the reader to tears was retranslated as a hope that it had not reduced him to tears.

It is not suggested that room acoustics have such a drastic effect, but they can be quite devastating at times, and some experiments in speaker placement, especially on stereo, are often worth while.

A couple of interesting examples of the use of reflected sound recently came to our notice.

The first was in a very spacious lounge, with a secondary section at one end as shown in Fig. R/20. There was a large 3-speaker system in one corner of the main room, and the owner decided to go in for stereo, but his wife flatly refused to have another loud-speaker in sight. An ingenious engineer, Mr. Thistlethwaite, was called in and he solved the problem by mounting the second speaker inside the alcove and facing the end wall, so that the sound was reflected back into the main room, resulting in excellent stereo and domestic harmony.

FIG. R/20.

Good stereo reproduction with one channel reflected from end wall, the speaker being mounted 10 ft. high, out of sight to listeners in large room.

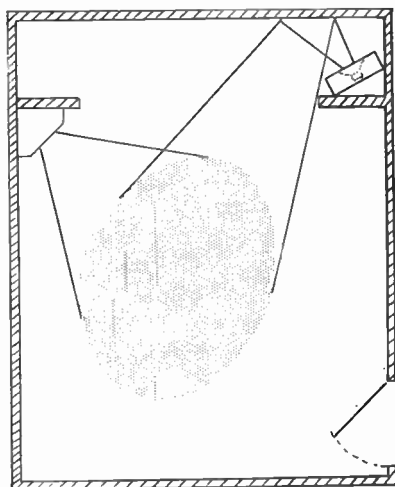

The second case is even more complicated and was heard by our Technical Editor during a visit to friends in the south of England. Fig. R/21 shows the general scheme of things.

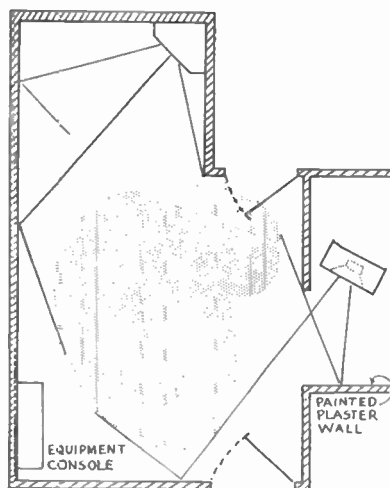

FIG. R/21. Unusual speaker set-up providing good stereo reproduction in the two listening areas which are shaded, and good general reproduction using both speakers with mono input.

ROOM RESONANCE See Eigentone.

RUMBLE FILTER A high-pass filter designed to attenuate the response of an amplifier below about 40 c/s to avoid the worst effects of rumble due to motor and bearing imperfections which cause vibration of turntable. Vertical rumble is the more serious and shows up on stereo, especially when high volume levels are used.

Most high-class amplifiers now include a rumble filter as an integral part of the circuit, the makers having found it necessary to protect themselves from unmerited complaints since the advent of disc stereo.

S

S.D.R. Suddeutscher Rundfunk, Stuttgart.

S.M.P.T.E. Society of Motion Picture and Television Engineers (U.S.A.), 55 West 22nd Street, New York 36, N.Y.

A professional body similar to our Television Society but including members specifically associated with the film industry. Publishes *S.M.P.T.E. Journal*.

SABIN A unit of sound absorption named after the famous American scientist Wallace Clement Ware Sabine (1868–1919) who literally opened the window to the study of architectural acoustics.

A surface is said to have an absorbency of one Sabin if it absorbs as much sound as 1 sq.ft. of open window.

SAND FILLING A useful method of avoiding panel resonance in cabinets. Two sheets of plywood or hardboard with $\frac{1}{2}$ " to 1" of sand between them, according to area, are very satisfactory. Ordinary builder's sand answers the purpose, but must be thoroughly dry, otherwise warping of panels will occur.

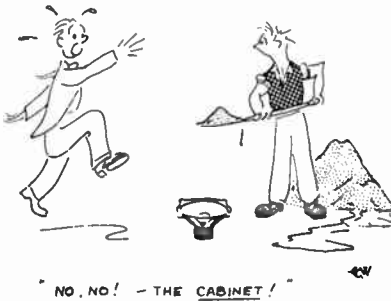

FIG. S/A.

The art of sand filling.

SCREEN, ACOUSTIC A movable partition used in broadcasting and recording studios to form a section having different acoustic ambience. The screens are usually 6/7 ft. high, with a reflecting surface on one side and a thick layer of absorbent on the other.

SELECTIVITY This normally relates to the tuning of radio sets, but according to our cartoonist can serve another useful purpose.



FIG. S/1.

A robot record player.

"This model's ultra selective."

SERIES When electrical components are connected in series, the same current flows through them all.

The effective value of capacitors in series is the same as resistors in parallel. A simple formula for values in pairs is $C_E = \frac{C_1 \times C_2}{C_1 + C_2}$

Similarly, the total value of resistors in series is the same as for capacitors in parallel and is simply the arithmetical sum of the individual resistors. This applies also to inductors.

With inductors, mutual coupling should be avoided by spacing them a few inches apart or orientating them at right angles to each other.

SHELLAC A hard resin-like substance produced by a species of beetle, mainly in India. Also the source of cochineal.

It is used in pressing 78 rpm gramophone records when mixed with carbon black, copal and slate dust.

Pure shellac is sometimes used for setting styli in pickups.

SHIELDING The shielding or screening of sensitive circuits is often necessary to protect them from the influence of spurious magnetic or electrostatic fields.

Magnetic screening is effected by encasing critical components such as pickup cartridges, tape heads and low level transformers in mu-metal or similar high permeability alloy. The interfering flux lines then pass along the screening case and avoid the interior.

The stray alternating field radiated by gramophone motors or by mains transformers in portable tape recorders may be reduced by casings of cast-iron or mu-metal. It is often worth while running the mains lead to a gramophone turntable motor in screened flex where hum or interference is severe.

Electrostatic screening is carried out by earthed copper or aluminium cans. Valves in low level stages of preamplifiers and tape recorders are usually surrounded by earthed aluminium cans. Similarly, low level signal leads should be screened with *closely woven* tinned copper braid.

Mains transformers of good quality should be equipped with an earthed screen of copper or aluminium foil between primary and secondary windings to avoid the transfer of mains-borne RF interference to critical parts of the circuit.

SIBILANCE A fault in reproduction in which consonants and, in particular, "s" sounds are given unnatural prominence. The effect may be due to extremely close spacing between speaker or singer and microphone, or to microphone and loud-speaker resonances. It is very difficult to eradicate but the application of a little treble cut above 3 kc/s is usually beneficial.

SIGNAL TO NOISE RATIO The total amount of hum and random noise at the output terminals of an amplifier is usually quoted in dB relative to full output. Thus, if the total noise voltage is one 10,000th of the terminal voltage at full output, the signal-to-noise ratio is 80 dB.

It is fairly easy to achieve this in a power amplifier, but the addition of a preamplifier will usually reduce the figure to about 65 dB and the effect of hum in pickup leads, etc., may well bring the margin down to 50 dB or less, which spoils the reproduction—especially with loudspeakers which have a good bass response.

It is interesting to note that if you have a 5 watt and a 20 watt amplifier, each with a signal to noise ratio of 80 dB, and you test them both at 5 watts output, the 20 watt model will show 6 dB higher noise level, but this only relates to noise produced in the main amplifier. In other words, it is easier to produce a quiet 5 watt amplifier than an equally quiet 20 watt model, which after all is not very astonishing.

SINE WAVE A waveform depicting simple harmonic motion. A pure sound at a single frequency, free from distortion and harmonics, produces a sinusoidal waveform, illustrated in Fig. S/2.

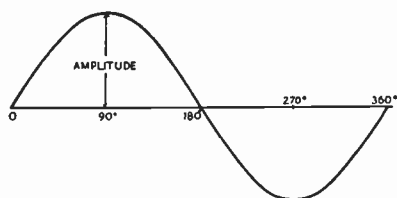

FIG. S/2.

One cycle of a sine wave.

SKIN EFFECT At high frequencies alternating currents tend to concentrate in the outer layers of a conductor thereby increasing the current density in that region. This has the effect of increasing the resistance of the wire as frequency goes up due to the fact that the cross sectional area in use diminishes. The phenomenon is known as skin effect and it becomes very important in RF circuits when it is necessary to minimise resistance losses.

Methods of combating skin effect include:

1. Use of large diameter wire.
2. Silver-plated wire in which outer layers have maximum conductivity.
3. Tubing at very high frequencies where centre of conductor is redundant.
4. Litz wire made up of several fine strands separately insulated.

SONE A unit of loudness used in the measurement of ear characteristics. A pure tone of 1,000 c/s at 40 dB above the listener's threshold of hearing is equal to one sone. A tone twice as loud is two sones, and so on.

In contrast, the phon unit is specified with reference to a fixed sound pressure level of 0.0002 dynes/sq.cm.

SOUND Sound consists of vibrations which can be heard through the ear. Musical sounds are produced by fairly continuous and regular vibrations with pleasing harmonics. Non-musical sound, such as noise and speech, is irregular in duration and is made up of random frequencies mostly outside the harmonic series.

Many people derive a lot of satisfaction and pleasure from sound as they go through life, but in this noisy age it can also be a confounded nuisance and a simple invention whereby we could close our ears would come as a boon and a blessing.

A few of the more important aspects of sound are touched upon under the following headings:

Intensity. The intensity of sound in a specified direction at a given point in space is defined as the rate of transmission of sound energy in ergs per second through an area of 1 sq.cm. normal to the direction of transmission.

Sound Waves. In Tyndall's book on *Sound*, published in 1869, it is pointed out that sound waves are dispersed and reflected in a similar way to waves on the surface of water which has been disturbed, and this is illustrated by the very beautiful effects of Fig. S/3.

In this case, the water was disturbed at a point in a circular vessel midway between the centre and the circumference.



From Tyndall's book on Sound, 1869.

FIG. S/3. *Ripples on the surface of water which are similar to sound waves.*

There are actually two types of sound wave: spherical and plane.

In a spherical wave, the wavefront is a continuous spherical surface in which pressure variations for all parts of the surface are in phase.

The pressure and particle velocities in a spherical wave are not in phase.

In a plane wave the wavefront is a plane surface in which pressure variations for all parts are in phase.

Pressure and particle velocities are also in phase.

A standing wave is produced by two equal plane waves travelling in opposite directions, when pressure and particle velocities are 90° out of phase.

Speed of Sound. This varies in air with temperature. At 22°C or 71.6°F the velocity is 344.8 metres/sec. or 1131.2 ft./sec. In brick the velocity goes up to 12,500 ft./sec., and in steel to 16,500 ft./sec.

Attenuation. The attenuation of sound in air increases with frequency and varies with humidity.

Sound Spectrum. This is a graphical representation of the magnitude of the various components of sound related to frequency. Fig. S/4 shows the analysis of the sound produced by a violin and a piano at A 440 c/s, although it must be remembered that the spectrum will vary according to the loudness at which the note is played.

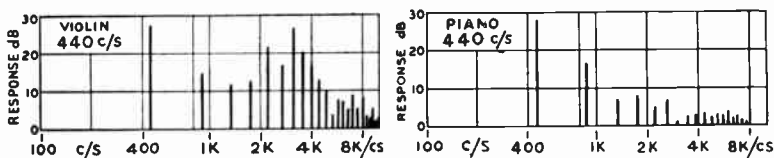

From Olson's Musical Engineering.

FIG. S/4. Sound spectrum or harmonic analysis of violin and piano tones.

SOUND-LEVEL METER A measuring device comprising microphone, calibrated amplifier and special pointer instrument designed to indicate sound intensity levels in dB with respect to 0.0002 dyne/sq.cm. at 1000 c/s.

To cover various conditions of use it is usual to provide three frequency-response characteristics or "weightings".

40 dB equal loudness contour.

70 dB " " "

Flat frequency response.

SPEECH COIL See Voice Coil.

SPIDER This was the name given to the centring device of moving coil loudspeakers before the corrugated disc became popular. The title was probably evolved because many of the devices had spidery limbs of weird and wonderful shape; the longer the limb, the greater the flexibility. The device is still in use on certain models.

SQUARE WAVE A waveform which alternates between minimum and maximum values with negligible rise and fall time, comprising a very wide range of component frequencies.

A square wave generator is useful for rapid testing of electrical circuits, including amplifiers. Defective operation is revealed as an alteration in the shape of the output waveform and is comprehensively illustrated in Fig. S/4A.

The square waves as generated in row A are not perfect, but they serve their purpose. The bending of the horizontal lines at 50 and 200 c/s in row B show poor LF performance; the rounding over at 1,500 and 5,000 c/s shows poor HF response. As regards row C, the performance at 50 and 200 c/s is very good, and the harmonic content at 1,500 and 5,000 c/s indicates that the response of the amplifier is well maintained up to 35 kc/s.

Square wave inspection also exposes faults such as instability, ringing, peaky response, phase shift, etc.

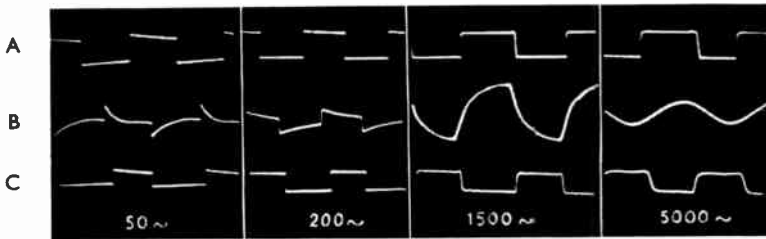

FIG. S/4A. Square waves at 50, 200, 1,500 and 5,000 c/s.

- A As generated.
 B As reproduced by radio set.
 C As reproduced by wide range amplifier.

SQUAWKER A name given to mid-range loudspeakers in America which is even less flattering than referring to bass units as woofers.

STACKED HEADS Term applied to magnetic tape recording and reproducing heads which are mounted in line one above the other. This is now standard practice for stereo tapes and has replaced staggered heads, an arrangement where the heads were set about $1\frac{1}{4}$ " apart, making correct alignment more difficult.

STABILITY In amplifiers employing negative feedback the phase of the feedback signal may change at frequencies well below or above the audio range. When this occurs the feedback can actually become positive and cause instability unless the magnitude of the feedback signal is reduced below a critical value.

The conditions for stability were expounded by H. Nyquist who found that for any amplifier to be stable the total gain around the feedback loop must fall below unity when the phase of the feedback becomes positive.

STEREO is the recording or transmission of sound by a system which includes information regarding position of sound sources in space. Spatial information is carried by two or more channels in which the sound signals differ in respect of intensity, phase or time of arrival at the respective microphones. The amount of extra information transmitted increases with the number of channels, but for domestic use two are considered adequate as well as being economical.

To obtain the full benefits of the two channel recording, two separate channels of reproduction must also be used, thus making good stereo a much more costly installation than good mono.

The main advantages of two-channel working are fuller and rounder bass, sweeter treble, and a general improvement in clarity and naturalness. The actual placing of the performers and instruments does not seem to be important.

But you must have high quality recording and reproduction to distinguish, say, the oboe from the clarinet. Good mono is still streets ahead of cheap, second-rate stereo, and always will be.

There is one sphere in which stereo appears to have no scope. We refer to those "pop" records, mostly with crooners, which today contain so much artificial echo and reverberation that it does not matter whether you play them mono or stereo, but which nevertheless sell in vast numbers.

Our fancies are wayward and random;
 What suits me may nauseate you:
De gustibus non disputandum,
 And likewise *chacun à son goût.*

(From More Occasional Verses by George Walker.)

Stereo Reproduction. Although the best method is to use two full range speakers 6 to 10 ft. apart, compromise is often necessary and quite good results can be obtained by the following arrangements. These include an isolating transformer to avoid an increase in the cross-talk between channels which may ruin the stereo effects. Suitable transformers are available at a cost of about 30s.

STEREO SYSTEMS

- A. One bass and two treble speakers.
- B. One full range speaker and one treble unit.
- C. Two widely spaced main speakers with a third to "fill in the middle".

Circuit diagrams and general instructions for use now follow.

SYSTEM A

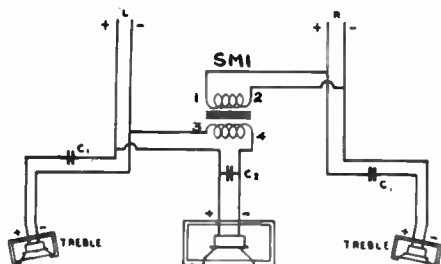

FIG. S/5.

Two treble speakers with common bass unit and mixer transformer SM1.

The capacitors C_1 are 30 Mfd each with 10/16 ohm speakers, or 60 Mfd for 6/10 ohm types. With 2/3 ohm speakers the equivalent value would be 120 Mfd, but it would be more economical to use a couple of matching transformers and work at 10/16 ohms.

The shunt capacitor C_2 has a similar value and its purpose is to roll off the output of the bass speaker above about 300 c/s where the treble speakers begin to take over. This capacitor could be replaced, often at lower cost, by using a series inductor, say 6.5 mH at 10/16 ohms, 3.2 mH at 6/10 ohms, or only 1.6 mH at 2/3 ohms.

The centre speaker could be a full range model, but in this case it may require attenuating with a constant impedance volume control adjusted for optimum results, as it spoils the stereo spread if too loud; or better still, use a tapped inductor in series as a tone control, thus retaining full bass output.

For optimum results on stereo, the treble speakers should respond down to 300 c/s. Associated volume controls may be an advantage here.

Location. The best arrangement is to have the bass speaker in the middle and two identical treble speakers 6/7 ft. apart and not less than 3 ft. above floor level.

The bass speaker can, however, be moved into a corner without much loss of balance, because low frequencies always spread themselves around the listening room and are not very directional.

SYSTEM B

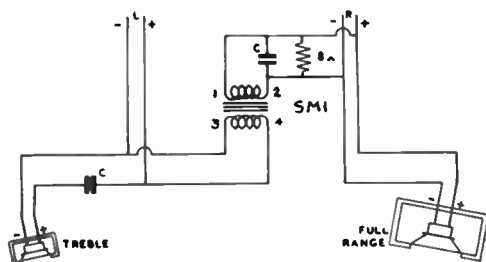

FIG. S/6.

*Full range speaker on one channel with treble speaker on the other.
C = Each 30 Mfd with 10/15 ohm speakers, or 60 Mfd at 6/10 ohms.*

Owners of a first-class full range speaker system can convert to stereo by adding a treble unit as shown here, the SM1 feeding all the bass into one speaker.

However, the stereo results are not so good as those obtained from a symmetrical installation, unless the acoustic set-up of the treble unit is the same as the treble section of the full range speaker, which would obviously give a good balance.

For general quality of reproduction it is obviously better to retain a good system in this way than to get rid of it and install two so-called matched but inferior stereo speakers.

SYSTEM C

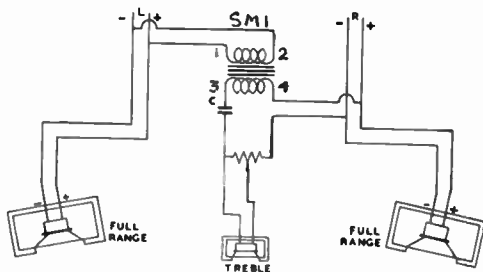

FIG. S/7.

Widely spaced main speakers, with third unit to "fill in the middle".

Very good results are possible here. The value of C will depend on how much "middle" is required. At 4 Mfd with a 10/15 ohm speaker, the response begins to fall below about 4000 c/s. At 8 Mfd things begin to happen below 2000 c/s, and so on. A volume control to regulate the output is almost essential.

Phasing. If a circuit is wired up in accordance with the diagram, the phasing should be correct. It is advisable to check by reversing the connections to the SM1 either 1 and 2 or 3 and 4. Using a record with plenty of bass the reproduction will sound thin when phasing is incorrect.

Radio. The adoption of a multiplex system for the broadcasting of stereo from a single transmitter would no doubt lead to an upsurge of interest in stereo, but it will probably be a year or two before the various countries can agree as to the best system to be used.

STEREOPHONER A passive circuit arrangement invented by Professor Hermann Scherchen for dividing the sound spectrum between two loudspeakers with mono input. In its commercial form the device is inserted between amplifier and loudspeakers which are spaced apart as for stereo. The input to the left-hand speaker is rolled off slowly above 600 c/s whilst that on the right takes over above 300 c/s, thus providing some overlap at middle frequencies.

The effect is quite impressive on choral and orchestral works, but the system cannot give the depth and stereophonic character obtained by two-channel recording and reproduction.

STEREOSONIC The name given by E.M.I. to their stereo recordings which were available commercially on tape four or five years ago, using the Blumlein closely coupled microphone technique.

STROBOFLASH A gas discharge tube associated with an audio oscillator and triggering circuit designed to produce brilliant flashes of light of extremely short duration and variable rate of repetition.

Such a device will appear to stop or slow down high speed cyclic motion and is extremely useful for observing the behaviour of loudspeaker cones under dynamic conditions, including the effects of overloading. The peculiar, undulating effects which are sometimes produced in cone surrounds can also be studied at leisure.

STROBOSCOPE A pattern of bars engraved on disc or turntable which appear to be stationary when running at the correct speed and viewed by a lamp operated from ac mains at the specified frequency.

The number of bars (N) for a speed of S rpm and a mains frequency of f c/s is given by the formula:

$$N = \frac{120f}{S}$$

The following table gives the common values in use, but the speeds are only *exact* in the five cases printed in heavy type. Stroboscopic perfection seems to be reached at 50 cycles and $16\frac{2}{3}$ rpm, where the bars are not even one degree under.

<i>Speed rpm</i>	50 c/s	60 c/s
78	77	92
45	133	160
33½	180	216
16⅔	360	432

FIG. S/8. Stroboscope bars per cycle for 50 and 60 cycle mains.

Stroboscopes can also be used to check tape recorder speeds.

STUDIOS There can be no doubt that the prophecy made by Percy Wilson in 1929 that recording studios would in the course of time be designed with controlled acoustic conditions has been carried out almost to a stage of perfection.

Some of the fine B.B.C. studios have been illustrated under Concert Halls, so we will content ourselves here by including two photographs of the new television studio recently opened by Associated-Rediffusion at Wembley Park.

Built at a cost of £1 million, this is today the largest TV studio in the world and measures 140×100 ft., with an effective clear height of 40 ft. A general view with cameras and microphones is given in Fig. S/8A.

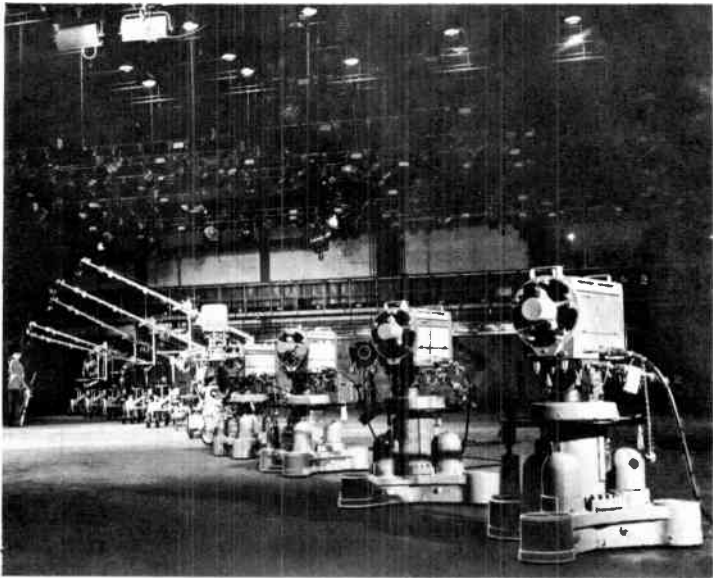

FIG. S/8A. *General view of Associated-Rediffusion's TV Studio 5 at Wembley Park.*

A very interesting point is that the studio can be divided into two self-contained, acoustically isolated units by lowering a pair of partitions weighing 25 tons each and giving acoustic separation in excess of 68 dB. A picture of these mammoth acoustic screens is reproduced in Fig. S/8B on facing page.

The two partitions measure 88 × 30 ft. each, and when raised leave a clear working height of 30 ft. in the large studio, each half of which is fitted with a separate floor to avoid transmission of sound mechanically when the two studios are in use separately. The two floors must not touch by expansion due to temperature variation, and yet must not jar a camera passing over the isolating gap, nor must they be disturbed by the passage of a load such as a double-decker bus. Some floor; some studio!

STYLUS The stylus situation has settled down to the use of diamond points in high quality pickups, and sapphires in the popular market where a good deal of wear and tear still takes place. With diamonds playing at 3 to 4 grms or less, wear is virtually non-existent. In theory, the radius is 1 mil for LP mono records and $\frac{1}{2}$ mil for stereo grooves, with a possible compromise at 0.75 mil. In fact, all the LP replacement styli examined for us by Mr. Watts were actually 0.75 mil radius.

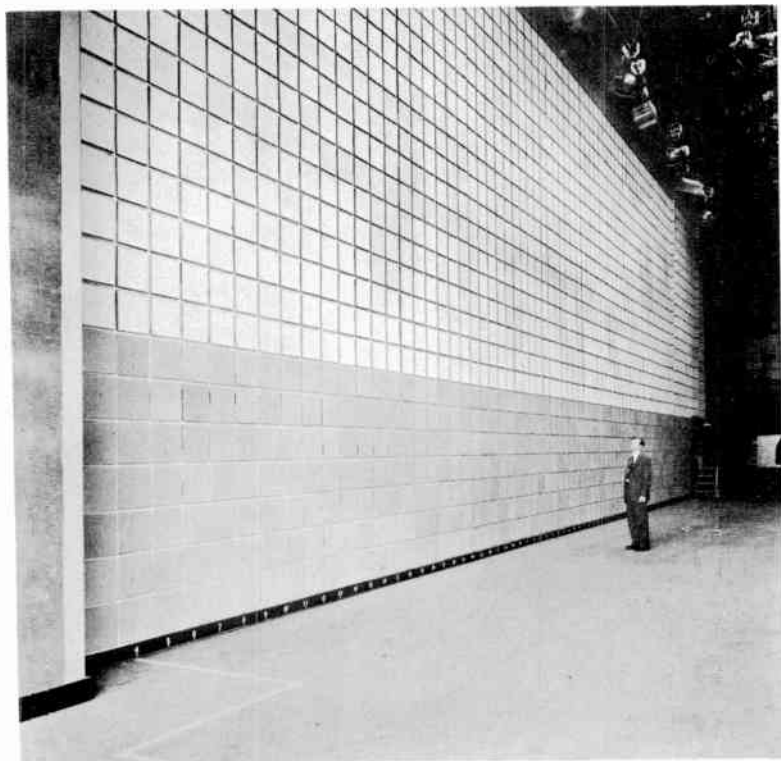

FIG. S/8B. *Vertical lifting partitions in A-R Studio 5, designed and installed by Geo. W. King Ltd. of Stevenage.*

All-round standards of shape and finish are today very good, as the following photomicrographs clearly show.

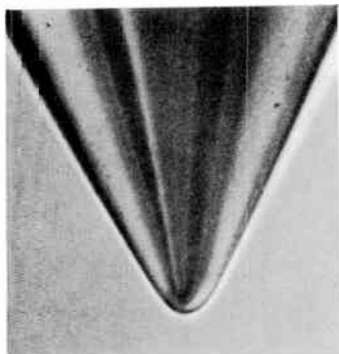

FIG. S/9. *First-class diamond LP stylus with excellent polish. Mag. 250x.*

Courtesy S. Kelly.

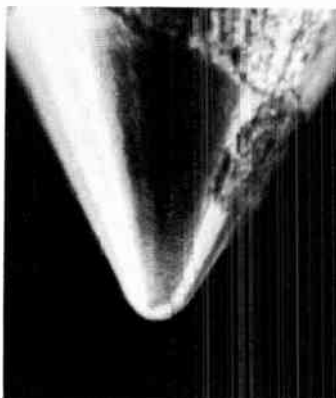

FIG. S/10. Average commercial diamond LP stylus sold for replacement purposes at 27s. (plus 8s. 8d. purchase tax). The blob of cement on one side is not visible to the naked eye and does not interfere with the tracing of the stylus in the groove. Mag. 250x.

In Figs. S/11 and S/12 we see average 0.75 and $\frac{1}{2}$ mil sapphire points as sold retail at 4s. 6d. (plus 1s. 6d. purchase tax) for replacement purposes. The shape and finish are very good.

FIG. S/11. Typical LP sapphire stylus. Mag. 250x.

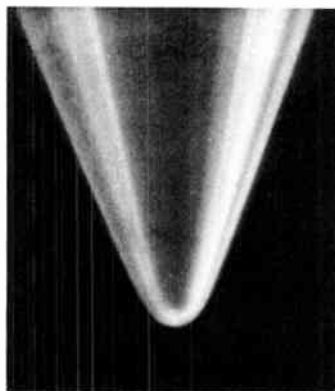
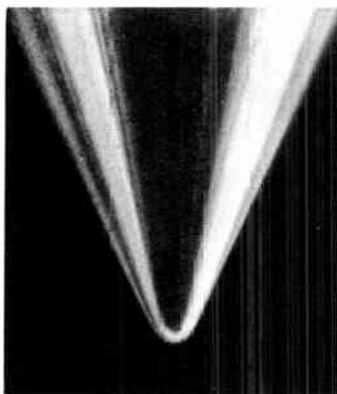

FIG. S/12. Typical $\frac{1}{2}$ mil sapphire for stereo. Mag. 250x.

Photomicrographs by C. E. Watts.



STYLUS-HOT When cutting microgroove and stereo discs it is now universal practice to use a stylus tip which is heated to a temperature of approximately 100°C by means of a small electric heating coil surrounding the shank.

The use of a hot stylus reduces surface noise by as much as 6 dB due to the smoother groove wall produced by this technique.

SUB-HARMONIC A sub-multiple of the fundamental frequency to which it relates.

In audio, the loudspeaker is the most fruitful source of sub-harmonics as a result of cone break-up at spot frequencies. A note is often produced an octave lower than the input signal, which must be a steady tone at a fairly high level to build up the resonance. The fault is worst with thin cones of the "loud" variety, and can be controlled by attention to texture, weight, shape and corrugations.

SUM AND DIFFERENCE In the present type of 45/45 stereo disc, lateral motion of the groove represents the sum of left and right-hand signals (L+R) whilst vertical motion represents the difference signal (L-R). Fortunately, the difference signal tends to be smaller than the sum which eases the problem of designing satisfactory pickups.

It has been suggested that a compatible record—which could also be played with mono pickups—might be produced by limiting the vertical motion still further, although to the lay mind this would appear to be a threat to the use of the full benefits of stereo or two-channel recording.

In pickups such as the Decca (London-Scott), three coils are used, and the required two-channel output is obtained by an ingenious sum and difference arrangement.

SUPERSONIC This relates to frequencies above the audio range or to speeds greater than that of sound in air (i.e. 770 mph).

SUPPRESSOR An arrangement of inductors, capacitors and/or resistors designed to reduce the transmission or radiation of electrical interference.

Although it is always preferable to suppress troublesome interference at the source this ideal line of attack is not always possible. Mains-borne interference can usually be reduced by filtering the ac supply as it enters the equipment and Fig. S/13 shows one method of supplying a domestic audio installation which includes a radio tuner.

Fig. S/14 illustrates a switch click suppressor used with gramophone turntables.

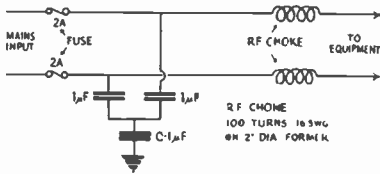

FIG. S/13. Circuit for reducing mains-borne interference with radio reception.

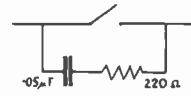

FIG. S/14. Simple switch click noise suppressor.

SURFACE NOISE The noise caused by random motion of a stylus in a record groove. The main causes are roughness in disc material, dust or grit in grooves, wear and tear, "bottoming" of stylus in groove or inaccurate tracing angle. Resonances in pickups and loudspeakers intensify the nuisance.

SURROUND See Foam Plastic and Roll Surround.

SWARF The thread of lacquer produced when a disc is being cut. This is removed by suction in professional equipment to prevent the swarf from fouling the recording cutter.

SWINGER A record in which the centre hole is not concentric with the groove spiral.

Bad swingers produce wow and affect the tracking of some pickups. An oversize centre hole can produce similar effects.

In record making today, great care is taken to avoid swingers. In fact, one of the most interesting machines I saw in the Decca Factory at New Malden is illustrated in Fig. S/15, and is used for exact location of the centre hole. The metal master is placed in the machine and slowly rotated as the operator observes a projected image of the grooves, magnification $100\times$. He slides the disc about until the grooves appear to move in one direction only and then stamps out the centre hole positioned to an accuracy of about $0.001''$.

SYNCHRONOUS MOTOR An ac motor in which the rotor runs in synchronism with the rotating magnetic field set up by the stator windings. There is no slip as in the induction motor and the speed is therefore dependent upon mains frequency.

If a synchronous motor is overloaded mechanically it does not slow up gradually but falls abruptly out of synchronism. Poorly designed motors also have a habit of running at half speed or other sub-multiples of the synchronous speed.

In this country, where the mains frequency is accurately controlled, the synchronous motor makes an ideal drive for the electric clock, a virtually perfect time keeper.



Courtesy Decra.

FIG. S/15. Machine for exact location of centre hole in metal master in relation to groove spiral.

T

TAPE RECORDERS The growing interest in tape recorders is illustrated in the following graph, which is based on an estimate of sales during the last six years, prepared for us by *The Financial Times*.

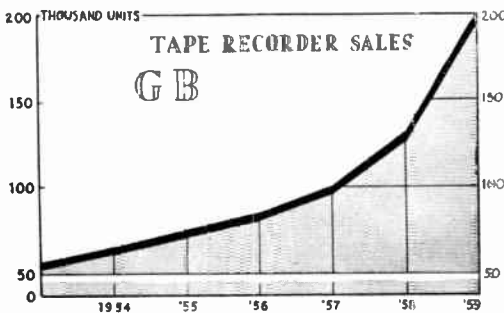

FIG. T/1.

Estimated sales of Tape Recorders.

The number of makes and models is no less remarkable, as was revealed in a comprehensive review given in the November 28th, 1959, issue of *Electrical and Radio Trading*.

More than 120 different models from 47 separate sources, two-thirds British, were available. The histogram of Fig. T/2 shows them arranged in price groups, all two-track machines.

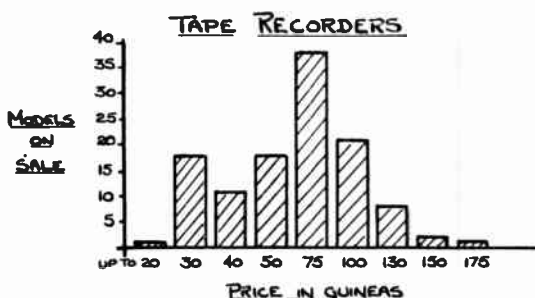

FIG. T/2.

Price groups of 120 different models of tape recorders available in Nov. 1959.

Compiled from *Electrical and Radio Trading Review*.

A swing to cheaper instruments began with the development of new, simple, single speed decks. There is one recorder costing less than £20, about 20 under 30 gns., and a further 10 below 40 gns.

The model costing less than £20 plays at $3\frac{3}{4}$ " /sec, and has inputs for mic, radio and pickup, but has no recording level indicator. The output is $2\frac{1}{2}$ watts feeding into a $7" \times 4"$ elliptical speaker, with provision for using a 3 ohms external speaker.

Most of the machines in the 26 gns. class play at $3\frac{3}{4}$ " /sec and have a magic eye recording level indicator. Some have monitoring facilities, and one model even includes dictation facilities. Spool size may be $5\frac{3}{4}"$ or less.

The largest class is still the 50 to 75 gns. range, working usually at $3\frac{3}{4}"$ and $7\frac{1}{2}"$ /sec, with 3 to 5 watts output, measuring or "counting" facilities, and taking spools up to 7" dia. Recording level meters are fitted to some machines.

Classification in speeds is rather complicated and works out as follows:

31	models	play	at	$3\frac{3}{4}"$	only
28	"	"	"	$3\frac{3}{4}"$	and $7\frac{1}{2}"$
28	"	"	"	$1\frac{7}{8}"$, $3\frac{3}{4}"$	and $7\frac{1}{2}"$
14	"	"	"	$3\frac{3}{4}"$, $7\frac{1}{2}"$	and 15"
10	"	"	"	$1\frac{7}{8}"$	and $3\frac{3}{4}"$
2	"	"	"	$7\frac{1}{2}"$	only
2	"	"	"	$7\frac{1}{2}"$	and 15"
2	"	"	"	15"	only
1	model	plays	at	$1\frac{7}{8}"$	only
1	"	"	"	$1\frac{7}{8}"$	and $7\frac{1}{2}"$
1	"	"	"	variable	speed

It is unfortunate—especially for the pre-recorded tape market—that Pope's lines:

*Where order in variety we see,
And where, though all things differ, all agree*

cannot be said to apply to tape speeds.

STEREO. It is significant that only 20 of the 120 models reproduce stereo, and only 10 of these actually record stereo, i.e. two channels simultaneously. These are all, *ipso facto*, in the high price groups, as good stereo recording and reproduction must cost more than good mono and must also require bulkier and heavier machines for equivalent techniques.

External Speaker. Practically all domestic machines are used for home recording, as very few pre-recorded tapes are being sold. Most of them are capable of producing better quality of sound than the standard reached by the internal loudspeaker which has to perform in a confined space. Connecting up a more ambitious speaker system often results in a marked improvement.

The cheaper models usually take a 3 ohms external speaker, but the better types may have 15 ohms output. It is worth while obtaining a reasonable match, and a small transformer should be used if the impedance of the external speaker is widely different. Suitable matching transformers can be bought at about 13s. 6d.

Tape recorders of continental origin may call for 5–7 ohms load. Here, either a 3 ohm or 10/15 ohm speaker could be used, as the mismatch would not be serious.

Professional Standards. For professional recording, a tape speed of 15"/sec is normally used. The higher speed reduces the incidence of wow and flutter, and improves the signal to noise ratio and the frequency response, and a big advantage is in ease of editing and reduced effect of tape drop-outs, which are small blind spots due to faults in tape. Such drop-outs obviously last four times as long at 3¾"/sec as at 15"/sec.

Professional standards are of course, costly. For instance, the Ampex Portable Model 351 sets you back £950, but you get a frequency response of 30 to 15,000 c/s, ± 2 dB at 15"/sec, with flutter and wow well below 0.15% rms, and you can rewind 2,400 ft. of NAB reel in one minute.

On the other hand, the results which are possible with commercial recorders in the £75 to £100 class are very good and we have used such machines at 7½"/sec quite successfully for demonstrations in the Royal Festival Hall and other concert halls, naturally with the required additional amplification.

PRE-RECORDED TAPE. You may remember the story about the talkative man who went to the north pole and his words froze as they came out of his mouth, with the result that he was choked to death by the exuberance of his verbosity.

We could say about tape records that they have been choked out of the market by the exuberance of their variety. Mono, stereo, two-track, four-track, various speeds, separate reels, cassettes? The situation has been hopeless, but appears to be clearing up in America, where the large recording companies have now agreed to adopt four-track stereo tape as a standard issue. This was advocated by Ampex a year ago and means that regular supplies of high quality $7\frac{1}{2}$ "/sec pre-recorded stereo tapes will be available, giving twice the playing time of previous two-track issues. This could be the answer to the high-class pre-recorded tape market.

The future may also be influenced by a new cassette or cartridge development described in the following paragraphs.

CBS-3M. These initials serve to introduce the new $1\frac{7}{8}$ "/sec tape cartridge developed by Columbia and Minnesota Mining & Manufacturing Co. in America, and demonstrated on March 22nd, 1960, by Dr. Peter Goldmark and his associates.

All the American audio journals reported in glowing terms on the demonstration.

The new cartridge, which is only about $3\frac{1}{2}$ " square and $\frac{5}{16}$ " thick, contains enough tape for 64 minutes playing time at $1\frac{7}{8}$ "/sec. Up to five cartridges can be accommodated on the large centre spindle of the playback machine giving a maximum of over five hours stereo at one loading.

The main secret of the development is the special tape which is reported to give a frequency response, dynamic range and background noise equal to the best $7\frac{1}{2}$ "/sec tape. The tape is only 150 mils wide and carries three tracks of 40 mils each for normal two-channel stereo use, with the third track available as an optional feature.

Observers at the first trade demonstration reported that the quality of reproduction was only slightly inferior when compared with 15"/sec master tape, from which it is clear that the CBS-3M cartridge is a major development.

In the technical sense it would appear that the CBS-3M system is aimed at the bulk market with the longest playing time at the lowest cost, otherwise the many inherent advantages of a tape speed of $3\frac{3}{4}$ " instead of $1\frac{7}{8}$ " would have been adopted.

As regards tapes eventually taking over from discs, the reader's guess is as good as mine, but it is nice with records to be able to see and select the movement or band we wish to play.

REPLAY CHARACTERISTICS. These are given in Fig. T/3. American tapes played on British equipment call for about 5 dB top cut at 10 kc/s.

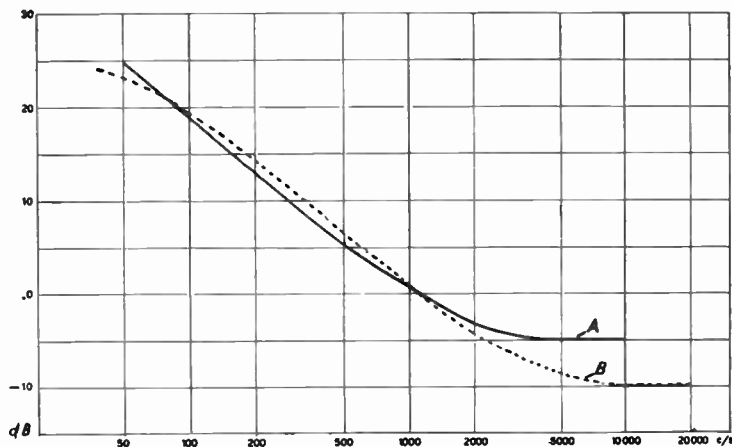

FIG. T/3. *Standard replay characteristics for 7½"/sec tapes*
 A—C.C.I.R. (British)
 B—N.A.R.T.B. (American)

TELEVISION The rapid growth of television during the last 10 years is shown in the following graph:

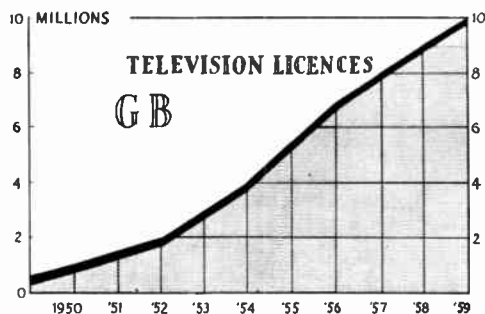

FIG. T/4.
Television licences.

The peak period of demand for TV sets was in the Autumn of 1959, but the Spring of 1960 shows a considerable decline in sales, as against a rise in demand for radio sets and gramophone records.

Although television is here to stay, it is a basic truth that it is easier to give continuous satisfaction to the ear than to the eye and ear together.

Serious music on TV is often disconcerting with too many close-ups and too much jumping about from one camera to another, plus indifferent standards of reproduction from cheap loudspeakers. The makers are not really to blame here, because adding £5 to the price of a TV set to improve the sound seems to render it unsaleable.

The quality of the transmitted sound is very good and it is worth while feeding into a good external loudspeaker system. Most dealers will arrange suitable extension points. As with tape recorders, the improvement can be quite startling.

The Future. There are three possible developments in TV:

1. Change from 405 to 625 lines per frame;
2. Opening of a third programme;
3. Colour TV.

Let us look briefly at these questions and consider the pros and cons.

1. *Lines per frame.* The systems in use at present are:

Great Britain	405	lines,	50	pictures	per	second
U.S.A.	525	„	60	„	„	„
Europe	625	„	50	„	„	„
France	819	„	50	„	„	„

Some people believe that the adoption of more lines automatically produces a better picture, but this is not so unless engineering standards are high, with improved definition in the horizontal plane from greater bandwidth. A well-produced 405-line picture looks better than a badly engineered 625-line effort.

A significant increase in the number of picture lines would not be worth while without an attendant improvement in receiver bandwidth, in which case the spot size of the cathode ray tube and overall uniformity of focus would assume greater importance, but British manufacturers are already producing large numbers of 625-line sets for export markets, so there would be no problem here, apart from cost.

2. *Third programme.* The opening of a third television programme would give an opportunity to introduce a 625-line service, with a view to a complete change from 405 lines in say 6 to 10 years.

According to Mr. Gerald Beadle, director of B.B.C. television, the available (unused) channels in Band Three should be used to extend the two services which already exist, to reach the three million people who are still outside the range of one or other of the services. Both the B.B.C. and I.T.V. could go into the ultra-high frequencies (Band Four) for their second programme if they had the courage to do a bit of pioneering.

The areas not covered by the B.B.C. in June, 1960, are shown in Fig. T/5.

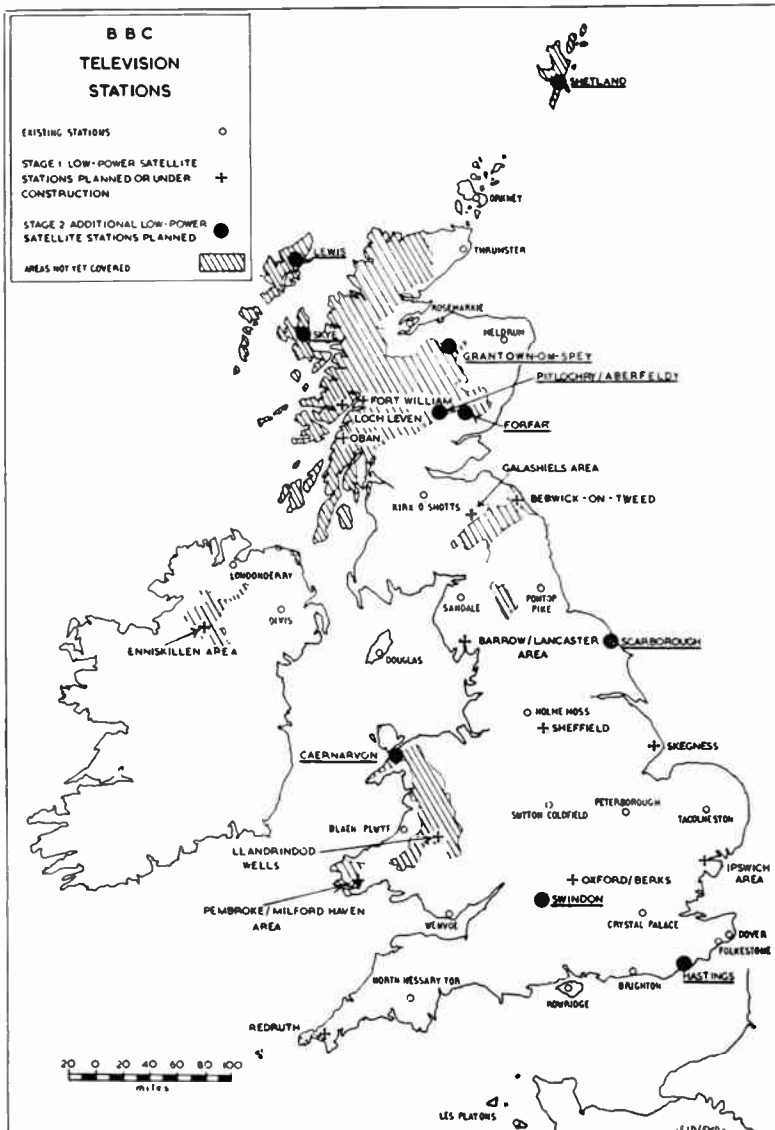

FIG. T/5. Television coverage by B.B.C., June, 1960.

3. *Colour TV.* So far as the B.B.C. are concerned, colour TV is already a practical proposition.

The difficulties which have been experienced in America sound a warning note, and may be summed up as follows:

- (a) High cost of sets for colour TV. £300 each is a likely *minimum* price in Great Britain.
- (b) Limited number of programmes which would be much less than the 8/9 hours a day now covered in black and white, due to higher costs.
- (c) Very great skill required for maintenance of sets. This service would be costly *and* difficult to find for several years. (Mr. M. G. Forster of the B.B.C. Engineering Information Dept. informs me that even *their* engineers find colour TV sets a tricky problem.)

These are some of the questions which the Television Advisory Committee have to consider. They are welcome to the task.

TV and TAPE. One of the most valuable developments in TV



FIG. T/6. *Ampex Videotape Recorder.*

services during recent years has been a method of magnetic recording for both sound and vision, thus cutting out the time-lag caused by developing film.

We are indebted to Rank Cintel Ltd. for details of the Ampex Videotape* Recorder illustrated in Figs. T/6 and T/7. Although costing about £25,000 each, 588 of these machines were in use throughout the world in April 1960, including 43 in the United Kingdom, of which 8 are with the B.B.C. No less than 426 are operating in the U.S.A., and 33 have gone to Japan.

*Ampex Corpn. Trade Mark.

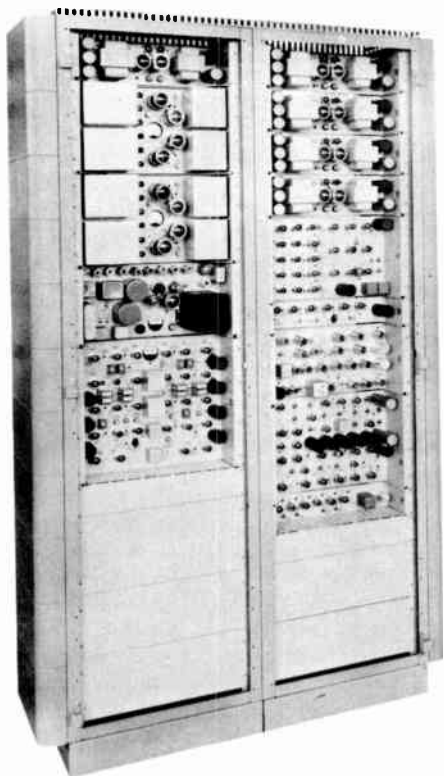

FIG. T/7.

Racks which accompany the Videotape machine and are (fortunately) included in the price.

The vision signal is recorded on 2" wide tape at 15"/sec by four recording heads spaced 90° apart around the circumference of a drum rotating at 15,000 rpm. The heads scan the tape at right angles to its direction of travel, producing recorded tracks which run obliquely across the tape with an effective speed of about 1600"/sec.

Additional longitudinal tracks are recorded along each edge of the tape, one of which carries the audio signal while the other contains control information.

The vision signal fed to the recording heads is a frequency modulated carrier of 5.5 mc/s with a maximum deviation of ± 1.3 mc/s. This technique avoids the necessity of recording down to zero frequency and reduces the recorded bandwidth which minimises the effects of imperfections in tape coating.

An hour's programme can be recorded on a 12" dia. spool containing 4,800 ft. of tape, which can be rewound in four minutes.

Results are so good that it is virtually impossible to detect when the Videotape Recorder is being used while viewing on a domestic television receiver.

Recordings can be monitored simultaneously and compared with the original, and may be replayed and viewed immediately after rewinding the tape—an ideal arrangement for “Tonight” programmes.

TERTIARY WINDING An auxiliary or third winding on a transformer as distinct from the normal primary and secondary windings, used in some amplifiers to provide overall negative feedback from the output transformer.

TEST RECORD Several records are available for testing the performance of audio systems.

Some have pure tones at fixed frequencies and gliding tones which sweep through the full audio range. Items of hi-fi music reproduction are often included, and test recordings for setting up a stereo installation can be very useful. Other discs are available for testing intermodulation distortion and also for testing channel separation on stereo.

Care should be taken when using frequency records not to overload a loudspeaker, and users should bear in mind that pickup, tone arm and room resonances often play havoc with results. For serious testing of amplifiers and loudspeakers a good audio oscillator is the only satisfactory source.

THREE CHANNEL Most of the excellent sound heard in cinemas when stereo was introduced a few years ago was the result of real three-channel recording and reproduction. The cost was very high, and in due course the wonderful sound failed to bring people in to see a poor film, so producers had to fall back on to cheaper pan-pot control. By this method, volume level into different channels is adjusted when the film is edited, and this gives a pseudo-stereo effect when heard through the different loudspeakers in the cinema. Production costs are reduced and few people enjoy a film any the less because of the absence of true stereo which involves separate recording channels.

True three-channel stereo is basically better than two-channel, and threats to introduce it into the domestic market have been heard. In the writer's opinion, this would be the height of folly because, in ordinary rooms, the difference is not sufficient to justify the use of three amplifiers and three loudspeakers. Two-channel stereo discs and tapes must be allowed to develop during several years without threats or stunts, to avoid further chaos in the industry.

This does not preclude the use of a third microphone during recording, to be suitably fed into the two main channels to avoid “hole-in-the-middle” effects, and the jumping about of solos, which afflicted many early stereo records.

THRESHOLD This word is used in connection with hearing and also in relating sound with feeling and pain.

The threshold of hearing is the loudness contour which is just audible to the average listener in very quiet surroundings.

The threshold of feeling is the loudness contour above which auditory sensation is augmented by feeling, although there are low organ notes in the 16 c/s region which can be felt across the abdomen but not heard by most ears.

The threshold of pain is the loudness contour above which human beings suffer distress.

TIME CONSTANT The time constant of a circuit is the product of its resistance and capacitance or inductance. Thus:

$$t = R \times C \text{ or } R \times L$$

where t is the time constant in seconds.

R is resistance in ohms.

C is capacitance in farads.

L is inductance in henries.

In equaliser or de-emphasis networks it is common practice to specify the shape of the response curve as a time constant because this makes it possible to calculate directly suitable component values.

The playback characteristic of Fig. R/13 is a combination of three curves having the following time constants:

$t_1 = 75$ microsec for HF de-emphasis.

$t_2 = 318$ microsec for constant amplitude.

$t_3 = 3180$ microsec for bass roll-off.

TONE This word has three meanings in the world of audio:

1. A sound having definite musical pitch;
2. The quality and strength of such sound;
3. The interval of the major second, e.g. C—D or F-sharp—G-sharp in the tempered scale.

No. 2 is easily the most fascinating. The tone of a good piano, and the tone produced by good singers, string players and wind instrumentalists must be counted as part of the joy of living by those who have ears with which to hear.

To be tone-deaf is to have no sense of pitch, but this does not necessarily mean to have no appreciation of music or tone quality.

On the other hand, to be extremely musical does not *per se* imply good judgment of tonal quality.

Tonal Balance. In sound reproduction it is more important to have good tonal balance than merely to go for extended frequency range. It is a fair rule of thumb to keep the number of octaves the same above and below 800 c/s. In setting up 2- or 3-speaker systems, with or without crossover networks, separate volume

controls can be a great help in achieving the desired balance throughout the audio range.

Many cabinet speakers are now fitted with mid-range and/or treble controls which also help in obtaining good balance on stereo.

TONE ARM A term originally used for the hollow arm coupling the sound box with the exponential horn on an acoustic gramophone. Its shape and method of construction had considerable effect on tonal quality.

The term is still in use to describe the carrying arm which supports the pickup cartridge as it traverses a record, but if properly designed the tone arm no longer affects tonal quality, although it may profoundly influence record wear and distortion.

The requisites of a high-class tone arm may be summarised as follows:

- (a) Low tracking error due to proper choice of offset angle and overhang;
- (b) Freedom from resonance;
- (c) Low bearing friction horizontally and vertically;
- (d) Little or no side thrust;
- (e) Optimum lateral and vertical inertia;
- (f) Static balance;
- (g) Height adjustment;
- (h) Adjustable playing weight;
- (i) Raising and lowering attachment;
- (j) Ability to play warped records and swingers.

Since the advent of disc stereo, great strides have been made in design, but the best devices are expensive and usually rather delicate.

With normal tone arms, in which the head is off-set to reduce tracking error, there is an inward force or side thrust acting on the stylus. Some recent designs have succeeded in minimising side thrust by ingenious arrangements of eccentric weights and unipivot suspension, with which a good stereo cartridge will track at less than 1 grm.

Unfortunately the stiffness of the connecting leads, which are normally covered with screening braid, becomes a serious problem at these extremely low playing weights and may produce a side thrust sufficient to send the stylus skating across the record. Looping the leads in a wide arc to reduce the torsional effect may offer a solution; but it is easier to work at 1 to 2 grms than at 0 to 1 grm.

There can, however, be no doubt that these delicately balanced arms which permit good tracking and tracing at extremely light weights give the best available quality from the finest pickups.

TRACING If the pickup stylus does not faithfully follow the original path of the cutter, there will be tracing distortion.

Playing at too light a weight can produce it, but the principal cause is too large a tip radius on the stylus, which prevents it from following the sharp inflections of the groove at high frequencies and high velocities and low surface speed, e.g. near the centre of the record.

FIG. T/8:-

Stylus tip fails to follow groove modulation and causes tracing distortion.

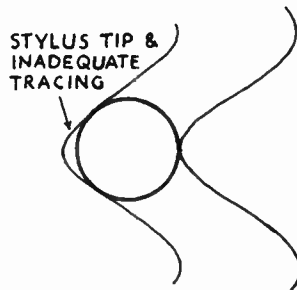

The use of $\frac{1}{2}$ mil points has greatly reduced the incidence of inner groove distortion.

TRACKING In recording, the cutterhead travels in a straight radial line across the disc, but pickups are usually mounted on an arm and cross the record on an arc.

Tracking error is reduced by offsetting the pickup head and by the correct amount of overhang. Tone arms must be accurately mounted in accordance with instructions to avoid undue distortion.

With good arm design and reasonable length, tracking error can be kept below $1\frac{1}{2}^\circ$ and the resultant distortion, which is mainly second harmonic, is likely to be below 1%, and considerably less than that from many other sources.

TRANSCRIPTION This is the name given to high quality recordings, pickups, tone arms and turntables.

TRANSDUCER A device which transmits energy—electrical, mechanical or acoustical—from one system to another. A loudspeaker is an example of an electro-acoustic transducer which converts electrical energy through mechanical to acoustical energy.

TRANSFORMER An arrangement of two or more magnetically coupled windings. A change in flux linkages in one winding produces corresponding changes in the others. Thus, 100 volts across a primary of 100 turns will develop 1 volt per turn, and 10 volts will appear across a secondary winding of 10 turns, the voltage and turns ratio being 10 to 1. See Fig. T/9.

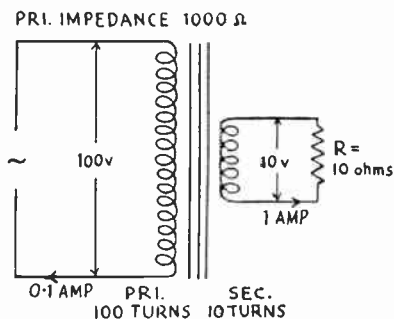

FIG. T/9.

Typical transformer working.

If the secondary is loaded with a resistance of 10 ohms and the current in the primary is 0.1 amp, the current in the secondary, neglecting the losses in the transformer, will be 1 amp. The primary circuit has an effective resistance of $\frac{100}{0.1} = 1,000$ ohms, against 10 ohms in the secondary. The transformer has modified the impedance by 100 times, i.e. the square of the turns ratio.

This impedance transforming property is used extensively in audio circuits for matching purposes, a typical application being output transformers. Various ratios are given in the table on next page.

TRANSIENT According to the dictionary, the word transient is an adjective meaning passing, momentary, of short duration or not lasting. During recent years it has been promoted to the status of a noun in audio circles.

For our purpose, the best definition of transient is an energy pulse where the intensity changes over a wide range in a very short time. A hand-clap is an excellent example.

Good transient response is essential for faithful sound reproduction, and is achieved by adequate frequency response, and avoidance of resonance, ringing and hangover, with electrical and mechanical damping where necessary.

Transient response involves both starting and stopping of sounds. The piano is an instrument in which the notes are built up rapidly but die away gradually, as illustrated in Fig. T/10.

It is obvious that the total transient shape of these piano sounds must be correctly recorded and reproduced if a natural result is to be obtained. Dr. Wm. H. George has proved this by playing a piano recording backwards; it sounds like a home-made organ suffering from chronic catarrh.

RATIO-IMPEDANCE TABLE

Transformer Ratio	Ratio Squared	SPEECH-COIL IMPEDANCE — OHMS									Transformer Ratio
		2	3	4	5	6	10	12	15		
10:1	100	300	300	400	600	800	1,000	1,200	1,500	10:1	
15:1	225	450	675	900	1,350	1,800	2,250	2,700	3,420	15:1	
18:1	324	650	970	1,300	1,950	2,600	3,250	3,900	4,900	18:1	
20:1	400	800	1,200	1,600	2,400	3,200	4,000	4,800	6,000	20:1	
22:1	484	970	1,450	1,950	2,900	3,900	4,900	5,900	7,350	22:1	
25:1	625	1,250	1,875	2,500	3,750	5,000	6,250	7,500	9,400	25:1	
30:1	900	1,570	2,350	3,140	4,700	6,200	7,650	9,400	11,800	30:1	
30:1	900	1,800	2,700	3,600	5,400	7,200	9,000	10,800	13,500	30:1	
32:1	1,024	2,030	3,070	4,100	6,150	8,200	10,250	12,300	15,400	32:1	
35:1	1,225	2,450	3,675	4,900	7,350	9,800	12,250	14,700	18,400	35:1	
40:1	1,644	3,200	4,800	6,400	9,600	12,800	16,000	19,200	24,000	40:1	
40:1	1,600	3,200	4,800	6,400	9,600	12,800	16,000	19,200	24,000	40:1	
42:1	1,764	3,570	5,300	7,000	10,500	14,000	17,500	21,000	26,500	42:1	
45:1	2,025	4,050	6,100	8,100	12,200	16,200	20,250	24,300	30,600	45:1	
48:1	2,304	4,600	6,900	9,200	13,800	18,400	23,000	27,600	*	48:1	
50:1	2,500	5,000	7,500	10,000	15,000	20,000	25,000	30,000	*	50:1	
52:1	2,704	5,400	8,100	10,800	16,200	21,600	27,000	32,400	*	52:1	
55:1	3,025	6,050	9,075	12,000	16,150	21,500	26,500	*	*	55:1	
56:1	3,136	6,270	10,000	13,500	20,000	27,000	33,000	*	*	56:1	
60:1	3,600	7,200	10,800	14,400	21,600	28,800	*	*	*	60:1	
62:1	3,844	7,700	11,500	15,400	23,000	30,800	*	*	*	62:1	
65:1	4,225	8,450	12,700	17,000	25,500	34,000	*	*	*	65:1	
68:1	4,624	9,250	13,900	18,500	27,000	*	*	*	*	68:1	
70:1	4,900	9,800	14,700	19,600	29,400	*	*	*	*	70:1	
75:1	5,625	11,250	16,900	22,500	33,000	*	*	*	*	75:1	
80:1	6,400	12,800	19,200	25,600	*	*	*	*	*	80:1	
85:1	7,225	14,500	21,700	29,000	*	*	*	*	*	85:1	
90:1	8,100	16,200	24,300	32,000	*	*	*	*	*	90:1	
95:1	9,025	18,000	27,000	*	*	*	*	*	*	95:1	
100:1	10,000	20,000	30,000	*	*	*	*	*	*	100:1	

N.B. Half any Ratio = Quarter Impedance. Double Ratio = 4 times Impedance.

Speech-coil impedance at 800 cycles is generally about 30% higher than its D.C. Resistance



FIG. T/10. Sound picture of melody played on 7' 6" Steinway grand.

From *Pianos, Pianists and Sonics*.

TRANSISTOR We are indebted to Siemens Edison Swan Ltd. for the following concise account of the origin of Transistors:

"Eleven years ago, during investigations carried out at the Bell Telephone Laboratories in America, the Transistor, or more precisely 'transistor action', was discovered by a brilliant team of three scientists, Shockley, Bardeen and Brattain who were later awarded the Nobel Prize for this work.

The word Transistor is derived from the expression 'TRANSfer resISTOR', which is a functional property of the device (i.e. there is a considerable difference in the input and output resistance).

In outward appearance there is little to suggest that the transistor can fulfil the function of a thermionic valve and an internal examination is even more perplexing since the 'element' of the transistor appears as a small piece of solid material to which three leads have been attached. There are no filament wires, anode plates or other delicate connections and supports found in the thermionic valve."

The symbols for valves and transistors are compared in Fig. T/11, and a typical transistor amplifier circuit is given in Fig. T/12.

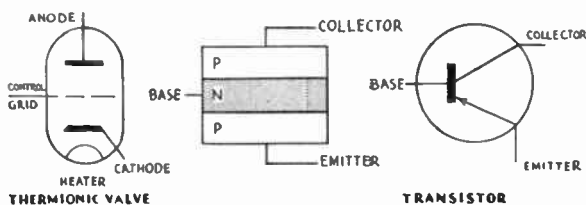

FIG. T/11. *Valve and Transistor symbols.*
Courtesy Siemens Edison Swan Ltd.

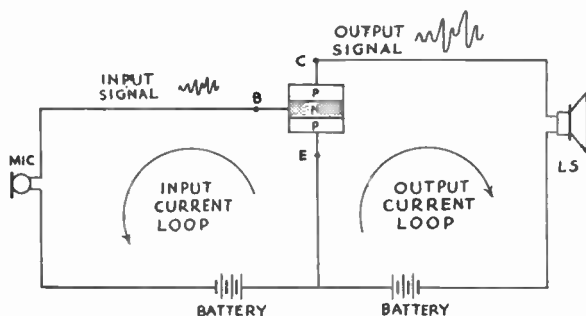

FIG. T/12. *The transistor as an amplifier.*

The transistor is based on a semi-conductor such as silicon or germanium, with a minute and critical amount of "impurity" such as antimony added to provide a number of free current-carrying

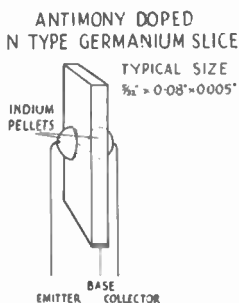

FIG. T/13.

Schematic of junction type transistor.

charges. Two electrodes—the emitter and the collector—are connected to this skilfully designed base, usually by an alloyed junction technique. Some idea of the arrangement and of the extremely small physical dimensions involved can be gleaned from Figs. T/13, T/14 and T/15.

FIG. T/14.

Model of transistor showing method of connecting wires to indium pellets on germanium crystal. Mag. 25x.

Courtesy Mullard Ltd.

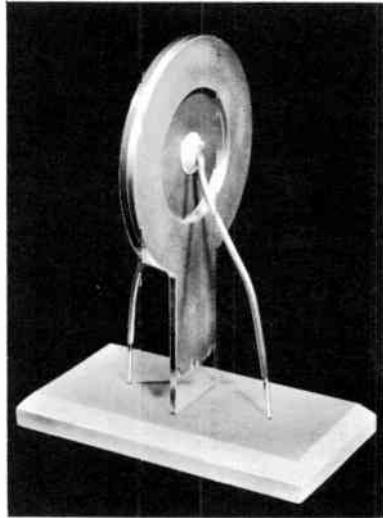

FIG. T/15. *Sorting and inspecting the indium pellets for the emitters and collectors of transistors.*

Courtesy Mullard Ltd.

It appears that germanium is now the main element used in transistors and can be obtained in the oxide form from flue ash resulting from burning Northumberland coal. (Messrs. Mullard do not explain why Yorkshire coal should not be used!)

PROS & CONS The main advantages of using transistors are:

1. Reduced size and weight;
2. No heater and less generation of heat in amplifier;
3. Lower current consumption;
4. Greater reliability;
5. Resistance to vibration, i.e. freedom from microphony.

The disadvantages are:

1. Higher costs;
2. May be permanently damaged by overload or excessive heat.

Very great precision in manufacture is called for, and prices have therefore been much higher than valves, but a high rate of production is leading to lower costs.

VARIOUS USES

Radio Sets. During 1959 more than half the radio sets sold in this country were (AM) transistor types. Only one transistor set for VHF reception appeared on the market, and this was of foreign extraction, but more are likely to appear shortly as suitable transistors are now becoming available.

Life of Battery. A small transistor radio will run for over 300 hours from a small battery weighing 6 oz. and costing 2s. 9d. Former valve-type portables ran for as little as 50 hours on batteries weighing 5 lb. and costing 22s. 6d.

Portable Record Players. Eleven out of 120 mono models were transistorised, and so were two out of 37 portable stereo players, all the remainder being mains driven.

Hearing Aids. All privately-sold hearing aids are fully transistorised, and National Health aids are now being produced with transistors but it will take a few years to replace the half-million or so valve-types already in use.

Amplifiers. Transistors with a collector dissipation of 30 watts are now available. A pair of these in push-pull will give 20/30 watts output.

Tape Recorders. Transistorised record, playback and bias circuits for tape recorder operation were described by Peter W. Black in the April, 1960, issue of *Wireless World*.

Commercial tape recorders with transistors, battery driven, are now appearing on the market.

Instruments. Many laboratory instruments, including oscillators, are being transistorised.

Acknowledgment. We should like to thank Mr. G. A. Cooksey of Mullard Ltd. for his help and guidance in the preparation of this section of the book.

Transistor Summary. This return to battery operation seems strange in a world which is drifting towards the use of more and more electrical appliances in the home. Handy size, convenience and portability are the main reasons, but *the very small sets*—giving satisfactory results on talks and news—are not so good for the enjoyment of music, where physical dimensions control the acoustic qualities, and a fair output in watts is still required for realism.

TURNOVER FREQUENCY The frequency at which a system undergoes a change in its mode of operation. In disc recording, the point at which a change is made from constant amplitude to constant velocity characteristics, around 700 to 1,000 c/s for LP records.

TWEETER A loudspeaker used for HF reproduction only, usually above about 2,000 c/s.

U

U.I.R. Union Internationale de Radiodiffusion. (International Broadcasting Union.)

ULTRASONIC TINNING The soldering of aluminium is rendered difficult using normal techniques due to the formation of aluminium oxide film on the surface of the metal. However, it is now possible to tin aluminium wire quickly and easily by immersing it in a bath of molten solder through which ultrasonic waves are travelling. The frequency is usually about 21 kc/s. The waves cause cavitation in the molten metal due to bubbles of dissolved gas which erode the surface of the aluminium and allow tinning to take place. The tinned wire can afterwards be soldered in the normal way.

UNSTABLE AMPLIFIER An amplifier which is continually or intermittently in a state of oscillation. The condition will be audible as roughness of tone, distortion or reduction in apparent power output. In severe cases the output valve electrodes will glow red-hot, transformer and voice coil windings may be burnt out, and motor-boating may enliven the proceedings.

V

V.O.A. Voice of America. (U.S. Information Agency.)

VHF Very High Frequency. This relates to radio transmissions on short wavelengths around 88–108 mc/s. Actually, 90 mc/s equals 90,000,000 cycles per second in frequency, although we cannot claim to have counted them. (Wavelengths used for AM, TV, etc., are outlined under “W”.)

VHF in the U.K. gives wide frequency range and practically no interference from foreign stations. FM, meaning frequency modulation, gives quiet background with little electrical interference, apart from possible motor car ignition troubles in fringe areas. Dynamic range is also better than with AM transmissions.

The areas now covered by the B.B.C. are shown in Fig. V/1.

Many people hold the view that a first-class B.B.C. concert from one of their best studios heard via FM is superior to any gramophone record. To enjoy this quality to the full, a high-class tuner with a good amplifier and loudspeaker system are obviously necessary, and this may set you back £75 or more, but is well worth the outlay in a good reception area.

On the other hand, if you live in a fringe area where reception conditions are poor, a commercial set with a restricted frequency range might be a safer investment, as HF distortion can be severe in some districts and may vary from house to house. In some cases, it sounds exactly as though the loudspeaker is faulty. Finding the best position for a good aerial often—but not always—effects an improvement on one or other of the local stations. Coaxial or balanced twin leads from aerial to set are essential.

Aerial Rental Service. In several districts it is now possible to hire radio and TV aerial service from firms who pick up the signals in a good location and run cables similar to the relay services. At 2s. or 3s. per week, for reliable signals and no unsightly aerials on the house, this can be a useful service in fringe areas.

Commercial Sets. According to a summary in the March 19th, 1960, issue of *Electrical and Radio Trading*, there were about 70 VHF and VHF/AM models of commercial sets on the market, 50 being British made. The prices ranged between £15 and £72 10s. to “suit all pockets”, and were grouped as shown in Fig. V/2.

The cheaper sets have 2/3 watts output, but the better ones reach 4/6 watts—ample for full domestic volume with a large external speaker.

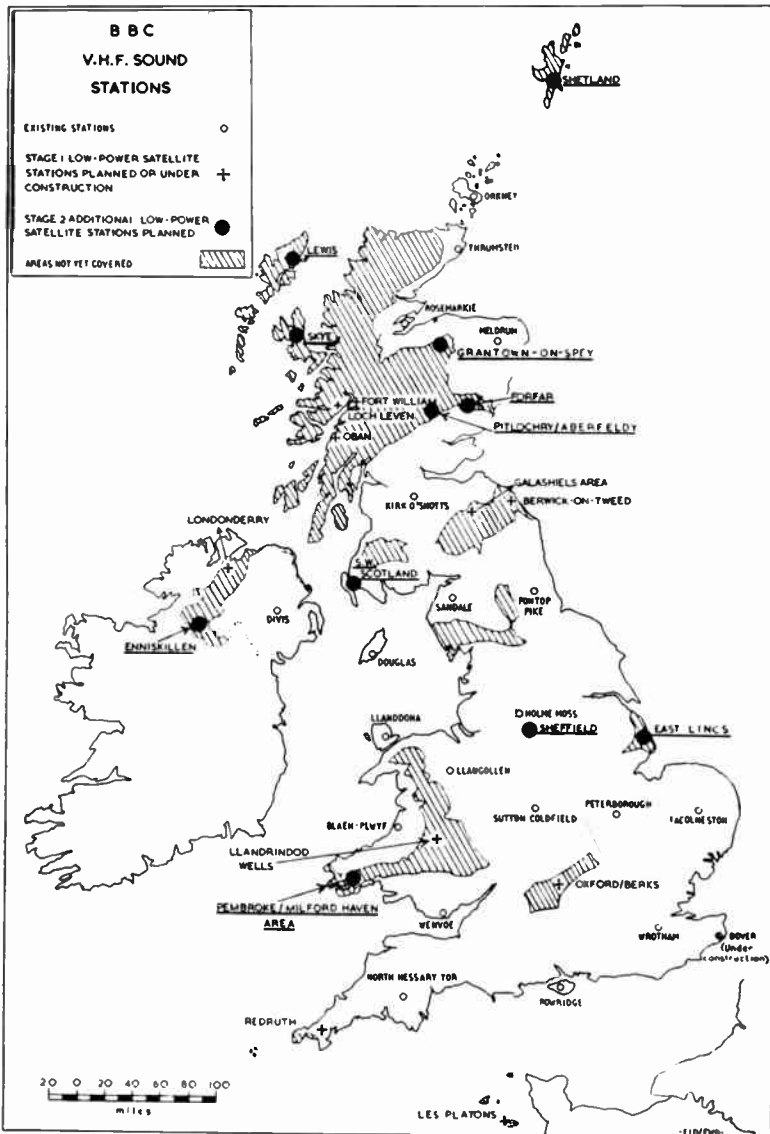

FIG. V/1. VHF coverage by B.B.C. transmitters.

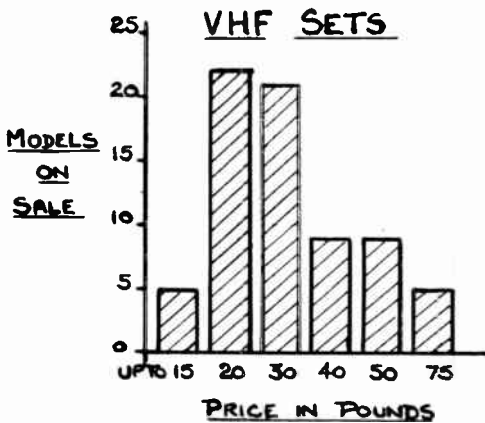

FIG. V/2. VHF sets available in March 1960 classified in price ranges.

The cheapest sets cover VHF only, but 52 include the medium and long wave services also.

Five models will work from dry batteries; one only is transistorised.

All are table sets; there is no console radio available today. Even where two or three small loudspeakers are fitted they are working in a confined space, and greatly improved results are usually obtained by switching over to a larger external speaker with sets in the higher price categories. Incidentally, the writer has enjoyed very good results during the recent promenade concerts using a commercial FM set costing £37 working into a compact three-speaker system costing rather more than the set. (And what is more, I am using a 10/15 ohm speaker with a 2/3 ohm set without matching transformer, but please don't tell the Technical Editor.)

With the small, cheap sets, using 2 watts pentode output, the addition of an expensive wide-range speaker is not recommended, as results may be very unsatisfactory. Even with VHF and FM it is still impossible to make a silk purse out of a sow's ear.

VELOCITY This word, meaning quickness or speed, is often used to refer to the velocity attained by a recording cutter or reproducing stylus as it traverses the record groove. Recorded level may be specified in terms of velocity either directly or in dB with reference to a zero level of 1 cm/sec rms velocity.

The sensitivity of pickups is often quoted in millivolts per cm/sec recorded velocity since with the majority of types (excluding piezo-electric models) output is proportional to stylus velocity. The peak velocity attained in modern LP records is of the order of 30 cm/sec.

VOICE COIL Also known as a speech coil, this is one of the most important components in a moving coil loudspeaker.

Wound with copper or aluminium wire on a rigid former, the coil must be perfectly round and stay so, otherwise it will foul the magnet and cause rattling; and the wire must be well fixed to the former because loose turns would vibrate and add buzzing and sizzling to the reproduction.

Copper wire is dense and suits the bass end, whereas aluminium is light and suits the extreme top. In a full range speaker the designer has to compromise one way or the other.

Impedance. The number of turns in the coil and the gauge of wire determine the dc resistance which, in turn, largely controls the impedance. The loudspeakers used by set makers are usually 2/3 ohms, whereas hi-fi and PA speakers are mainly 10/15 ohms in this country or 6/10 ohms in others.

There is no virtue in numbers here, apart from the fact that, with a given length of connecting lead, the power loss is about 5 times as great with a 2/3 ohms speaker as it is with a 10/15 ohms type. For distances less than 20 ft. the resistance of the leads is low, and may be ignored, and a 3 ohm speaker is quite effective fed via ordinary lighting flex. (For longer leads use power flex.)

Impedance varies with frequency, but for practical purposes may be taken as 30% to 50% above the dc resistance of the coil.

Amplifier Matching. If you connect a loudspeaker with a 4/6 ohms coil to the 15 ohms output points of an amplifier, it will draw more current and sound louder than a 10/15 ohms speaker hitched up to the same source, but the *maximum* available undistorted output will be less. True efficiency is derived from powerful magnets—not from low impedance.

Another important point is that the lower impedance would also tend to give more bass because it reduces the effective amplifier damping. For instance, a damping factor of 10 with a 15 ohms load is reduced to 2 with a 3 ohms load. But it should be remembered that reducing the damping may adversely affect other aspects of performance such as transient response.

VOLT The practical unit of electromotive force named after the Italian physicist Alessandro Volta, 1745–1827.

An emf of 1 volt across a circuit of 1 ohm resistance causes a current of 1 amp to flow.

VOLTAGE FEEDBACK A system of negative or positive feedback in amplifiers where the feedback signal is proportional to the output voltage. See NFB and Positive Feedback.

VOLUME COMPRESSION When broadcasting or recording programme material having a wide dynamic range, it is sometimes necessary to reduce the range to prevent overloading the equipment on loud passages and to avoid the signal "falling into" the random noise during quiet moments. The process of reducing dynamic range is called volume compression, and it may be carried out manually or automatically. The manual method with an operator or studio manager following a musical score is most usually employed and results in a more acceptable and artistic effect than the electronic method.

Volume compression is most necessary with background music and factory "Music While You Work" programmes, where dynamic ranges limited to 5-20 dB have been found desirable.

VOLUME EXPANSION To counterbalance volume compression, various ingenious methods of volume expansion during reproduction have been tried, but none has come into general use.

Volume expansion can hardly duplicate the original volume range because there is no way of determining the original volume levels. Many of the circuits which have been proposed introduce side effects such as harmonic and transient distortion which are worse than volume compression.

VU METER A standard volume indicator used widely in the U.S.A. and elsewhere. It was developed conjointly by the Bell Telephone Laboratories, C.B.S. and N.B.C.

The indicator employs a moving coil movement with full wave copper oxide rectifier, which responds to the rms value of the impressed waveform.

The scale is calibrated in volume units and percentage voltage.

The meter movement has standardised dynamic characteristics and a frequency response of ± 0.5 dB from 25-16,000 c/s.

The volume unit referred to expresses the level of a complex wave on the meter with respect to a reference level of 1 mW into 600 ohms at 1,000 c/s.

W

W.D.R. Westdeutscher Rundfunk, Cologne.

WARBLE TONE A frequency modulated audio tone used in acoustics to avoid sharp irregularities of measurement produced at isolated frequencies by standing waves and other causes.

WARPED RECORDS Although this fault is more likely to develop in tropical countries than in temperate climates, reasonable precautions to avoid it are advisable. For instance, I know from experience that it is unwise to leave expensive records on the back seat of a car where the sun can get at them. Even mild northern sunshine will warp the discs and make them wow or actually cause the pickup to skate across the surface.

One of the best methods of storage to keep records flat is the Wilson Wedge, described in the February 1956 issue of *The Gramophone*, and illustrated in Fig. W/1.

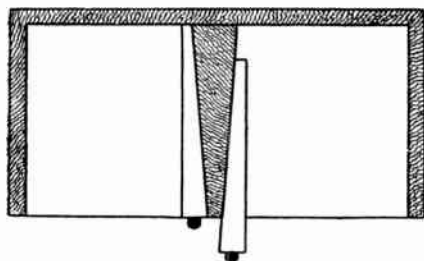

FIG. W/1.

Double record compartment with sliding wedges to keep discs flat.

From THE GRAMPHONE

All the records in one compartment should be of the same size, and the taper of the fixed wedge must be exactly the same as the taper of the two sliding wedges. When a slider is pulled out, the pressure is removed and a record is easily inserted or removed. Cardboard or plywood squares can be used to pack a partly-full compartment.

WATT The practical unit of power named after the Scottish engineer James Watt, 1736–1819. One watt equals one joule per second, and one ampere passing through a resistance of one ohm dissipates one watt.

LOUDSPEAKER WATTS/VOLTAGE TABLE

	<i>Voice Coil Impedance in ohms</i>					
	2	3	6	10	12	15
0.5 watt	1.0	1.25	1.7	2.3	2.5	2.8 volts
1 "	1.4	1.7	2.4	3.2	3.5	3.9 "
2 "	2.0	2.5	3.5	4.5	4.9	5.5 "
3 "	2.4	3.0	4.2	5.5	6.0	6.7 "
4 "	2.8	3.5	4.9	6.3	6.9	7.8 "
5 "	3.2	3.8	5.5	7.1	7.8	8.7 "
6 "	3.5	4.3	6.0	7.8	8.5	9.5 "
7 "	3.8	4.6	6.5	8.4	9.2	10.3 "
8 "	4.0	4.9	6.9	9.0	9.8	11.0 "
9 "	4.2	5.2	7.4	9.5	10.4	11.6 "
10 "	4.5	5.5	7.8	10.0	11.0	12.2 "
12.5 "	5.0	6.1	8.7	11.2	12.2	13.7 "
15.0 "	5.5	6.7	9.5	12.2	13.4	15.0 "

WAVELENGTH The distance between adjacent corresponding points in a progressive wave.

WAVELENGTHS OF SOUND IN FEET AND INCHES

<i>Frequency</i> <i>c/s</i>	<i>Wave-length</i> <i>ft.</i>	<i>Frequency</i> <i>c/s</i>	<i>Wave-length</i> <i>ft.</i>	<i>Frequency</i> <i>kc/s</i>	<i>Wave-length</i> <i>in.</i>
25	44.8	180	6.3	1	13.0
30	36	200	5.6	2	6.5
35	32	225	5.0	3	4.5
40	28	250	4.4	4	3.2
45	25	275	4.1	5	2.7
50	22.4	300	3.4	6	2.2
60	18	350	3.2	7	1.9
70	16	400	2.8	8	1.6
80	14	450	2.5	9	1.5
90	12.5	500	2.2	10	1.3
100	11.2	600	1.7	15	0.9
120	9	700	1.6	20	0.67
140	8	800	1.4		
160	7	900	1.2		

The frequency bands, with wavelengths, used or available for broadcasting and television in this country are as follows:

	<i>Frequency</i>		<i>Approx. Wavelength Metres</i>
	160—255 <i>kc/s</i>	Long Waves	1877—1178
	525—1605 "	Medium "	571—187
	3950—4000 "	Short "	76—75
	5950—6200 "	" "	50.4—48.4
	7100—7300 "	" "	42.2—41.1
	9500—9775 "	" "	31.6—30.7
	11700—11975 "	" "	25.6—25.0
	15100—15450 "	" "	20.15—19.4
	17700—17900 "	" "	16.95—16.78
	21450—21750 "	" "	14.0—13.8
	25600—26100 "	" "	11.72—11.5
Band 1	41—68 <i>Mc/s</i>	T.V.—B.B.C.	7.32—4.41
2	88—95 "	VHF—FM	3.41—3.16
3	184—211 "	T.V.—I.T.V.	1.63—1.42
4	470—582 "		0.639—0.516
5	{ 606—790 "		0.495—0.380
	{ *760—960 "		0.380—0.313

*Shared with other services.

WHISTLE FILTER A steep cutting filter designed to reject signals around 9 kc/s and used to suppress the annoying whistle which often afflicts AM broadcasting reception in fringe areas. Similar interference is sometimes produced by TV sets working in the near vicinity.

WHITE NOISE A signal comprising a noise spectrum in which the distribution of energy is constant per cycle and covers a wide frequency range. White noise is very useful in testing loudspeakers as resonant humps and poor transient or frequency response are quickly exposed, but it is not an absolutely complete test because very few people know exactly how perfect white noise ought to sound.

A useful source of whitish noise is available from FM receivers working without aerial or mis-tuned.

WOOFER A not very flattering name which originated in America to designate loudspeakers used for the reproduction of low frequencies. (We originally wrote "The name given to American bass loudspeakers" but we thought again!)

WOW Variation in pitch of a recording at a very slow rate, usually less than 10 c/s. (See Flutter.)

Y

YAGI Hidetsugu Yagi is most famous for his invention of the Yagi aerial which employs a complex system of reflectors and directors to sharpen the pickup pattern. He published his first paper on the aerial in 1928 when he was Professor of the College of Engineering of Tohoku Imperial University at Sendai, Japan.

Professor Yagi was appointed President of Musashi Technical College, Tokyo, in 1958.

Z

ZERO LEVEL A reference power level used by professional audio engineers. Zero level is now generally taken as 1 milliwatt dissipated in a pure resistance of 600 ohms. This is equivalent to 0.775 volts across a 600 ohm load.

CONCLUSION

In producing non-technical books on technical subjects, the question of what to leave out often assumes greater importance than the problem of what to put in. With a glossary of this type the difficulty is greater than ever, because it could run to 1,000 pages or more without dealing with every aspect of the subject.

I am inclined to agree with Samuel Johnson's verdict:

Books that you may carry to the fire, and hold readily in your hand, are the most useful after all.

Such publications can also be used as bedside companions. We have therefore aimed at a handy volume at a handy price, and the contents are aimed, figuratively speaking, at the non-technical reader, although our Technical Editor has come through with quite a lot of facts and figures which, he assures me, should help rather than hinder the layman.

One of the most interesting things to strike us in the preparation of this A to Z was that few of the words or titles used are to be found in a dictionary. The latest we could obtain was *The Shorter Oxford English Dictionary* (in two volumes totalling some 2,500 pages and costing £6 15s.) with revisions made in 1956.

Taking letter A, out of our 39 headings only 15 were to be found in the dictionary and only 8 of these referred to any audio meaning. The proportion with other letters was similar, and the conclusion is that about 80% of the titles or headings normally used in audio are peculiar to the art or science involved, which seems to make out a good case for an A to Z on the subject.

Finally, I should like to point out that the amount of space devoted to a heading has been determined by what we had to say about it rather than by its relative importance. For example, five pages have been used on Column Mounting, not because we look upon columns as the ideal loudspeaker system, but because they lend themselves to home construction at low cost, and results with concrete are very good in rooms of average size. Acoustically-designed enclosures with very low resonance bass speakers and matched treble units give a better performance but are not a practical proposition for the home constructor, and plans or working diagrams are not usually available. These compact assemblies also cost three or four times as much as a concrete column set-up.

And so we come to the end of the tenth publication to come out of the small Wharfedale book department. Whether or not we have succeeded in complying with Mr. Ladhams' command that the reference book must be readable and entertaining, time alone will tell. In any event, I can truthfully say that Mr. Cooke and I have enjoyed the exercise of producing the book (and completing the project!) in the fairly quick time of 6/7 months.

G. A. BRIGGS

Other GERNSBACK LIBRARY Books

59—SERVICING RECORD CHANGERS. Detailed drawings show how to make repairs. Full servicing information. 224 pages. \$2.90

61—TRANSISTOR TECHNIQUES. How to work with and test transistors; measurements; practical building projects. 96 pages. \$1.50

62—TV—IT'S A CINCH! Snappy conversational style with hundreds and hundreds of drawings helps you breeze through TV. 224 pages. \$2.90

63—TRANSISTOR CIRCUITS. Over 150 practical circuits, using transistors only. A guide for the experimenter. 160 pages. \$2.75

64—UNDERSTANDING HI-FI CIRCUITS. Explains how modern audio circuits work and what you can expect from them. 224 pages. \$2.90

65—SERVICING COLOR TV. How to repair color receivers. Illustrated with photos, drawings and troubleshooting charts. 224 pages. \$2.90

66—BASIC AUDIO COURSE. Fundamental audio concepts; describes microphones, equalizers, amplifiers, speakers, enclosures. 224 pages. \$2.75

67—ELEMENTS OF TAPE RECORDER CIRCUITS. Complete coverage of the electronic portion of tape recorders. 224 pages. \$2.90

68—TV AND RADIO TUBE TROUBLES. Service TV and radio receivers by understanding tube troubles. Recognize symptoms quickly. 224 pages. \$2.90

69—ELECTRONIC HOBBYISTS' HANDBOOK. Scores of practical circuits for the hobbyist. Parts lists on construction projects. 160 pages. \$2.50

70—ELECTRONIC PUZZLES AND GAMES. Build and design them. Dozens of projects which need no special parts or tools. 128 pages. \$1.95

71—AUDIO DESIGN HANDBOOK. Each chapter covers a separate section of an audio system, from preamp to speaker. 224 pages. \$2.90

72—OSCILLOSCOPE TECHNIQUES. Deviation and interpretation of waveforms. Hundreds of photographs of actual traces. 224 pages. \$2.90

73—AUDIO MEASUREMENTS. Test equipment and all phases of audio measurement from basic amplifier to microphone. 224 pages. \$2.90

74—MODEL RADIO-CONTROL. Coders, transmitters, receivers, power control, servos, transistors. Theory and construction. 192 pages. \$2.65

75—TRANSISTORS—THEORY and PRACTICE. Theory, equivalent circuits, amplifiers, oscillators, tests and measurements. 160 pages. \$2.95

76—SERVICING TRANSISTOR RADIOS. Fundamentals, types of construction, testing, stage-by-stage servicing procedures. 224 pages. \$2.90

77—GUIDE TO MOBILE RADIO. Industrial and railroad radio, selective and remote systems, maintenance and licensing. 160 pages. \$2.85

78—RAPID RADIO REPAIR. Fix radios quickly and easily. Separate sections deal with receiver types, servicing techniques, troubles. 224 pages. \$2.90

79—DESIGNING & BUILDING HI-FI FURNITURE. Fundamentals of design, woods, tools, professional finishing, polishing and retouching, furniture styles, placement. 224 pages. \$2.90

80—STEREO . . . HOW IT WORKS. Complete coverage of stereo, discs, tapes, multi-channel, installation, pseudo-stereo. 224 pages. \$2.90

81—PRINTED CIRCUITS. Designing and making printed circuits, repairs, subminiaturization, applications. 224 pages. \$2.90

82—TUBES AND CIRCUITS. A basic text of vacuum tube theory, practice and application. 192 pages. \$3.45

83—FUN WITH ELECTRICITY. A build-it-yourself book of motors, meters and transformers. A career builder. Helpful to beginners of any age. 128 pages. \$2.65

84—MARINE RADIO FOR PLEASURE. Covers theory, operation, maintenance and regulations. Electronics for the power boat fan and the service technician. 160 pages. \$2.95

85—HOW TO GET THE MOST OUT OF YOUR VOM. Basic meter, kits, accessories, measurements, servicing. 224 pages. \$2.90

86—INSTALLING HI-FI SYSTEMS. Reduce headaches of buying and installing hi-fi and stereo units. Electrical and structural, room layout problems are covered. 224 pages. \$3.20

87—PRACTICAL AUTO RADIO SERVICE AND INSTALLATION. Time and nerve saving hints on installation, removal and servicing the specialized problems of power supplies and hybrid sets. 160 pages. \$2.95

89—TRANSISTOR PROJECTS. No theory. How-to-build-it details for pocket radios, test equipment and electronic gadgets. 160 pages. \$2.90

90—HI-FI MADE EASY. Audio explained for the layman in easy-to-understand form. Profusely illustrated. 224 pages. \$2.90

92—FUNDAMENTALS OF SEMICONDUCTORS. Carefully detailed explanations of transistors, diodes, thermistors, varistors and photo sensitive devices. 160 pages. \$2.95

94—TRANSISTORS—How to test them. How to build all-transistor test equipment. Audio and Rf generators, signal tracer, scope calibrator and other useful units are described. 96 pages. \$1.95

96—HOW TO FIX TRANSISTOR RADIOS & PRINTED CIRCUITS. Two volumes of theory, practice and service hints for portable and auto radios using transistors. 320 pages. \$5.90

101—TV TROUBLE ANALYSIS. Waveforms and circuit defects of TV receivers covered along with the most usual failures of components. 224 pages. \$3.20

102—PRACTICAL TV TROUBLESHOOTING. Useful repair techniques based on actual servicing experience. An easy guide for tough repair jobs. 128 pages. \$2.35